

TABLE OF CONTENTS FOR CLASS ACTIVITIES

	Page
Syllabus	i
Courses and Students, TA Orientation	1
Activity #1a: Light Patterns	5
Activity #1b: Alternative Conceptions: Light Patterns	19
Activity #2: Analyzing the Force Concept Inventory	21
Activity #3: Analyzing Open-ended Questions	31
Activity #4: Demonstration of Discussion Session	51
Activity #5: Cooperative vs. Traditional Discussion Sessions	
Activity #6: Problem Solving: Expert vs. Novice	59
Activity #7: Problem Solving Strategies and Problem Solving in Lab	67
Activity #8: Practice Using a Problem Solving Strategy	79
Activity #9: Demonstration of Laboratory Instruction	83
Activity #10: Practice Lab Teaching	89
Activity #11: Designing a Group Problem	93
Activity #12: Typical Objections to Cooperative-Group Problem Solving	109
Activity #13: What do you do next? Intervening in Groups	113
Activity #14: Physics and Writing Errors in Students' Lab Reports	
Activity #15: Classroom Climate and Cheating	117
Activity #16: Case Studies: Diversity and Gender Issues	121

TA Orientation — Schedule and Syllabus

Fall 1999

Class Meeting Information

Aug. 23 - Sept. 2

8:45 am to 5 pm (with an hour break for lunch)

The goals of this course are to:

- introduce you to some of the current research in learning and teaching
- show how we apply this research to classroom instruction
- help you develop some of the skills necessary for a successful experience as a teaching assistant in the introductory physics courses

Texts and Reading Materials

- Booklet of selected readings (Booklet)
- Student's Lab Manual (SLM)
- Instructor's Handbook (IH)
- The Competent Problem Solver

Instructors

Patricia Heller
Dept. of Curriculum and Instruction
☎ 370 D Peik Hall ☎ 5-0561
✉ helle002@maroon.tc.umn.edu

Ken Heller
Dept. of Physics
☎ 260 A Physics ☎ 4-7314
✉ heller@mnhep.hep.umn.edu

Dave Engebretson
☎ S9 Physics ☎ 4-8840
✉ engebret@physics.spa.umn.edu

Vince Kuo
☎ 161A Physics ☎ 5-9323
✉ vkuo@physics.spa.umn.edu

Grading (see page 6 for a complete breakdown)

- **Activities.** Since most people learn best by doing, throughout the course there will be activities to let you practice what you are learning. These activities will sometimes be completed in groups with all group members receiving the same grade. These assignment have varying point values depending on their difficulty and importance. (See page 6 for their exact point value.) These activities account for about a third of your grade (35 points).
- **Homework.** Periodically, you will be assigned homework to be completed by the next class meeting. The homework is intended to give you time to consider the issues raised. Most homework will take about an hour. These assignment have varying point values depending on their difficulty, so you should refer to page 6 for their exact point value. The homework accounts for about a third of your grade (33 points).
- **Quizzes.** There will be a five to ten minute quiz given precisely at 8:45 every morning and collected by 9 am. The quizzes will be on the reading material assigned for the day and/or on the material discussed the previous day. The purpose of the quizzes is to ensure prompt attendance and adequate preparation for the class activities. These quizzes account for about a third of your grade (32 points).

- **Grading scale:**

A 88-100 points, B 75-87 points, C / S 64-74 points, F 0-63 points

Since the course is graded on an absolute scale, it is possible for everyone to get an 'A'. The Physics Department requires that you at least get a 'C' in this course.

REMEMBER you will not receive a grade for this course until the end of Spring Semester. Grades will be recorded as "X" until you successfully complete the Fall and Spring Teaching Seminars. You need to pass both terms of this course with a 'C' or better.

Date	Topic	Readings & Homework (DUE on the date listed)
Mon 8/23	<p>Morning: Introduction to the Department</p> <p>Afternoon: Advising and registration.</p> <p>Reception and Pictures</p>	
Tues 8/24	<p>Morning & Afternoon:</p> <p>Introduction to being a TA. TA Responsibilities.</p> <p>What difficulties do students have learning the concepts and principles of physics? Why? <i>Activities #1-3</i></p>	<p>Readings: Instructor's Handbook</p> <ul style="list-style-type: none"> • TA Responsibilities (6 pages) <p>Booklet -- Alternative Conceptions</p> <ul style="list-style-type: none"> • Wandersee, Mintzes, & Novak — Research on alternative conceptions in science, 177-183 & 185-191 (13 pages) • McDermott — Research on Conceptual Understanding in Mechanics (1.5 pages) • McDermott — Guest Comment (3.5 pages)
Weds 8/25	<p>Morning: How are discussion sections taught at UofM? Why?</p> <p>What difficulties do students have solving problems? <i>Activity #4-6</i></p> <p>Afternoon: What difficulties do students have solving problems (cont)? <i>Activities #7-8</i></p>	<p>Readings: Booklet -- Labs and Cooperative Grouping</p> <ul style="list-style-type: none"> • Martinez — What is Problem Solving (4 pages) • Larkin — "Processing Information..." (3.5 pages) • Heller, Keith, & Anderson — Teaching problem solving through cooperative grouping. Part 1 (9 pages) <p>Instructor's Handbook — Teaching a Discussion Session</p> <ul style="list-style-type: none"> • General Plan for Discussion Sessions (1 page) • Detailed Advice for Teaching Discussion Sessions (4.5 pages) <p>Homework #1: Complete Predictions and Methods Questions for Laboratory I Problem #1 and Laboratory III Problem #2</p>

Date	Topic	Readings & Homework (DUE on the date listed)
Thurs 8/26	<p>Morning: How are the labs taught at the U of M?</p> <p><i>Activity #9</i></p> <p>Afternoon: Preparation for peer teaching of labs.</p> <p><i>Activity #10</i></p>	<p>Reading: Booklet — Problem Solving</p> <ul style="list-style-type: none"> • Toothacker — A critical look at lab instruction... (3.5 pages) <p>Readings:</p> <ul style="list-style-type: none"> • FAQ About the Labs (7 pages) • General Plan for the Labs (1 page) • Detailed Advice for Teaching Labs (4.5 pages) <p>Homework #2:</p> <ul style="list-style-type: none"> • Read Appendix G: Lab Prep Programs (5 short pages) • Read Appendix E: Video Analysis of Motion (5 short pages) • Read: How to access lab prep programs (2 pages) • Read your assigned Lab (intro., problems) in SLM • Skim the relevant sections of textbook • Answer predictions and methods questions for all problems in the assigned lab
Fri 8/27	<p>Morning: Practice teaching Lab I & Rec I</p> <p>Afternoon: Introduction to research in the Department</p>	<p>Reading: Booklet</p> <ul style="list-style-type: none"> • Smith, Johnson & Johnson — Handouts (5 pages) <p>Homework #3: (due in the afternoon):</p> <ul style="list-style-type: none"> • Read 1301 Lab I in SLM • Skim the relevant sections of textbook • Answer predictions and methods questions for problems • Pass the computer lab prep program. <p>OR Peer Teach</p>

Date	Topic	Readings & Homework (DUE on date listed)
Mon 8/30	<p>Morning: Discuss Homework.</p> <p>What are the characteristics of good group problems?</p> <p>What are the best ways to "coach" students while they are working in groups?</p> <p><i>Activities #11-13</i></p> <p>Afternoon: Practice teaching Lab II & Rec II.</p>	<p>Readings: Booklet — Cooperative group problem solving</p> <ul style="list-style-type: none"> • Collins, Brown, & Duguid — Situated Cognition and the Culture of Learning, pages 32 & 37-42 (7 pages) • Heller & Hollabaugh — Teaching problem solving through cooperative grouping, Part 2, section III (pages 638 - 640, 2.5 pages) • Heller & Hollabaugh — Teaching problem solving through cooperative grouping, Part II, pages 640-644 (4 pages) [OPTIONAL] <p>Instructor's Handbook — Group Problems</p> <ul style="list-style-type: none"> • Characteristics of Good Group Problems ... (2 pages) • Cooperative Group Problem Solving (8.5 pages) <p>Homework #4: Solve Context-rich Problems</p> <p>Homework #5: (due in the afternoon):</p> <ul style="list-style-type: none"> • Read 1301 Lab II in SLM • Skim the relevant sections of textbook • Answer predictions and methods questions for problems • Pass the computer lab prep program. <p>OR Peer Teach</p>
Tues 8/31	<p>Morning Discuss Homework.</p> <p>Evaluating lab reports: Physics & Writing</p> <p><i>Activity #14</i></p> <p>Afternoon: Practice teaching Lab III & Rec III.</p>	<p>Readings: Booklet – Labs and Problem Solving</p> <ul style="list-style-type: none"> • Allie et. al. Writing Intensive Laboratory Reports (6 pages) <p>Homework #6: Use criteria to judge problems</p> <p>Homework #7: (due in the afternoon):</p> <ul style="list-style-type: none"> • Read 1301 Lab III in SLM • Skim the relevant sections of textbook • Answer predictions and methods questions for problems. • Pass the computer lab prep program. <p>OR Peer Teach</p>

Date	Topic	Readings & Homework (DUE on date listed)
Weds 9/1	<p>Morning: How can you teach for Diversity and personal interactions? What to do about cheating?</p> <p><i>Activities #15-16</i></p> <p>Afternoon: Practice teaching Lab IV & Rec IV.</p>	<p>Readings: Booklet — Sexual Harassment and Cheating</p> <ul style="list-style-type: none"> • Equal Opportunity Brochure, sections 1-10 (15 easy pages) • Shymanksy et al — Do TAs exhibit sex bias? (3 pages) • Seymour — Gender differences in attrition rates (9 pages) • Standards of Student Conduct — Sections IV and V (3 small pages) <p>Activity #16 - Read Case Studies</p> <p>Homework #8: (due in the afternoon):</p> <ul style="list-style-type: none"> • Read 1301 Lab IV in SLM • Skim the relevant sections of textbook • Answer predictions and methods questions for problems <p>OR Peer Teach</p>
Thurs 9/2	<p>Morning: Ethics and professional responsibility. (Room 166)</p> <p>Afternoon: How to teach the first lab session and discussion session</p> <p><i>Activity: Evaluation of Orientation</i></p>	<p>Reading : Instructor's Handbook</p> <ul style="list-style-type: none"> • First Team Meeting (4 pages) • How to enter course grades (2 pages)
Fri 9/3	<p>Morning: Visit research labs or take written exam</p> <p>Afternoon: Team Meeting with Faculty</p>	

Activities (by day completed): (35 total points)

Date	Act. #	Description	Max.	Earned
8/24	1	Alternative Conceptions -- Light Patterns on Screens	3	
8/24	2	Analyzing the Force Concept Inventory Questions	2	
8/24	3	Analyzing Open-ended Questions	2	
8/25	4	Demonstration of Discussion Session Instruction	2	
8/25	5	Cooperative vs Traditional Discussion Sessions	2	
8/25	6	Problem Solving - Exercise solution	2	
8/25	7	Problem Solving Strategies, Problem Solving in Lab	2	
8/25	8	Practice Problem Solving Strategy	2	
8/26	9	Demonstration of Laboratory Instruction	3	
8/26	10	Practice Lab Teaching -- Data Collection	2	
8/30	11	Designing a Group Problem	2	
8/30	12	Typical Objections	2	
8/30	13	What Do You Do Next? Intervening in Groups	2	
8/31	14	Physics & Writing Errors in Student's Lab Reports	2	
9/1	15	Scholastic Dishonesty is . . .	2	
9/1	16	Case Studies: Diversity and Gender Issues	3	

Homework (by day due): (33 total points)

Date	Hwk. #	Description	Max.	Earned
8/25	1	Predictions/Methods Questions: Lab Probs #1 & #2 (Act #4)	4	
8/26	2	Predictions/Methods Questions for Lab Problems Assigned	4	
8/27	3	Preparation for 1301 Lab I in ILM (or Peer Teaching)	4	
8/30	4	Solve Context-rich Problems using a Strategy	5	
8/30	5	Preparation for 1301 Lab II in ILM (or Peer Teaching)	4	
8/31	6	Use Criteria to Judge Context-rich Problems	4	
8/31	7	Preparation for 1301 Lab III in ILM (or Peer Teaching)	4	
9/1	8	Preparation for 1301 Lab IV in ILM (or Peer Teaching)	4	

Quizzes (by day given): (32 total points)

Date	Quiz	Topic/Readings	Points	Earned
8/25	1	TA Responsibilities, Alternative Conceptions, Problem Solving	8	
8/26	2	Labs FAQ, Lab Lesson Plans, Discussion Section Plans	4	
8/27	3	Cooperative Grouping	4	
8/30	4	Context-rich Problems	4	
8/31	5	Lab reports, Judging problems	4	
9/1	6	Sexual Harassment Policy, Cheating Policy, Gender Diff.	4	
9/2	7	First Team Meeting.	4	

Instructors' Notes for Day 1: TA Orientation (about 7 hours)

Date	Topic	Readings & Homework (DUE on the date listed)
Tue 9/8	Morning & Afternoon: Introduction to being a TA. TA Responsibilities. What difficulties do students have learning the concepts and principles of physics? Why? <i>Activities #1-3</i>	Readings: Instructor's Handbook <ul style="list-style-type: none"> • TA Responsibilities (6 pages) Booklet -- Alternative Conceptions <ul style="list-style-type: none"> • Wandersee, Mintzes, & Novak — Research on alternative conceptions in science, 177-183 & 185-191 (13 pages) • McDermott — Research on Conceptual Understanding in Mechanics (1.5 pages) • McDermott — Guest Comment (3.5 pages)

Activities

0. Sign-up sheet, nametags
1. TAs introduce themselves -- name, undergrad. institution, physics interest, any experience teaching
2. Staff introduce themselves.
3. Image of TA activity -- TAs individually write down what they think their TA duties will be, share with neighbor, then whole group.
4. U of Mn model for introductory physics courses; who are the students, and structure of intro. physics courses (Overheads)
5. TAs individually read section from handbook on TA duties -- we answer any questions
6. TAs compare and contrast their preconceived notion of duties and responsibilities with what they will do here at the U of Mn.
7. Goals and structure of TA Orientation
 - Goals and general topics
 - structure of summer course and seminars in Fall and Spring
 - reading, grading, quizzes, etc. (answer key on wall, returned homeworks in folders)
 - go through Wandersee et. al., reading -- skimming, etc.
 - tell about returned quizzes and homework in hanging folders
 - sign-up sheet everyday, food everyday

Day 1 Lesson Plan

8. Activity #1a: Light patterns pretest (Dave) *20 minutes*
4. Activity #1a: Light patterns tutorial in room 225 (Dave) *1 hour*
10. Return to 157 for discussion and Activity #1b *20 minutes*
11. TAs take the FCI test
12. LUNCH — we grade the FCI and print up results sheet
13. Activity #2: Analyzing the FCI (Pat and Ken) *1 hour*
14. Activity #3: Analyzing open-ended questions (Pat and Ken) *1 hour*
15. Remind students about quiz next morning at 8:45

Handouts

Preparation:

1. For class Make groups for Activities 2 & 3
 - Reading Booklet
 - Instructor's Handbook
 - Activities Packet
 - Homework Packet
 - Competent Problem Solver
 - New readings handout
 - Important people photos
2. FCI test and bubble sheets
3. FCI results (after lunch)
4. Group roles blanks
5. Group functioning sheets

Activity #1: Introduction to Alternative Conceptions (about 1.5 hours)

Introduction

Assign students to groups and have them discuss (1) how they learn best, and (2) some characteristics of good instruction. (OVERHEADS)

Activity #1a: Light Patterns

- a) Motivation: Before we begin, we are going to briefly illustrate some of the components of the instructional strategy we use at the University of Minnesota.

You will be able to compare and contrast these strategies with what you consider to be good instruction and good conditions for learning.

The focus of this short demonstration is the topic of light patterns. Here is the problem you will be focusing on. Please complete the prediction questions in your activity packet, pages 5-8. Hand them in.

b) Activity #1a: Have students go to lab room to complete the problem (see Activity Sheets, pages 9-17).

c) Closure: Discuss the similarities and differences between the lab activity they just completed and "conventional" labs.

Activity #1b: Alternative Conceptions -- Light Patterns

a) Motivation: Pass back the "predictions" to students. Although you have all probably had formal instruction in optics, you probably all had some difficulty applying this knowledge to real situations (at least we all did when we went through a similar activity.) In fact, you may have used some intuitive "alternative conceptions" to make your predictions.

b) Activity #1b: Turn to page 19 of your Activity Packet. I would like you to take some time to reflect on the experience you just had, from making the predictions to completing the exploratory lab problem. Which of these knowledge claims made by Wandersee, Mintzes, & Novak (1994) did you *personally* experience in some way? (You may not have experienced all of these claims, but certainly the majority.) I'll give you the first one -- Claim # 6. Each of your instructors in this course standing before you now had some alternative conceptions about Light Patterns!

c) Closure: Have students share some of their answers.

Review what all the instructional strategies that promote conceptual change have in common -- disequilibrium, intelligible, plausible, fruitful (OVERHEAD).

If there is time, review Claim #7 (Unintended Learning Outcomes) from the Wandersee et. al., (1994) article (OVERHEADS). Discuss the implications for teaching introductory physics students.

Activity #2: Analyzing the Force Concept Inventory (about 1 hour)

a) Motivation: "As a TA, one of your responsibilities will be to monitor and diagnose students' conceptual difficulties so you can help them both during class, and in office hours. The first tool you will have available is the Force Concept Inventory (FCI), which will be administered to students during the first week of classes. You will use the results of the FCI to form your first cooperative groups in your discussion and lab sections."

Tell students how the FCI was constructed -- uses many questions first asked in interviews they read about in the assigned articles; authors checked responses by interviewing several students after they took the FCI.

Show the TAs the results for both themselves and the students in the calculus-based course (handout).

b) Activity #2: Explain their group task briefly — every group should complete the question assigned to them first (see below), then go on to questions 19, 11, 15, 13, 17, and 4 in that order.

Group	Question	Group	Question
1	19b, c or d	8	11c
2	13b	9	17d
3	11b	10	15c
4	17a	11	13a
5	4a	12	11a
6	19a	13	19b, c, or d
7	13c	14	13b

Introduce and discuss "roles" (HANDOUT).

Model how to complete this activity by thinking out-loud and writing the answers for the first FCI question (Question #30 on page 22) on an overhead.

While the TAs are working, assign a question to each group. As the TAs finish the activity, give a **group processing sheet** to each group (HANDOUT).

c) Closure: Randomly call on one person from each group to share their answers to a question.

Show and discuss also the Hake Plot -- we are slowly making progress! (OVERHEAD)

Relate these results to the McDermott articles. Many students do not have a "consistent conceptual system" -- their understanding and use of a particular

Day 1 Lesson Plan

concept like force is ambiguous and unstable, so the answers they give are strongly dependent on the context of the situation. If TAs are interested, discuss work by Andrea diSessa (pieces of knowledge called "primitives") and Jim Minstrell (pieces of knowledge called "facets").

Activity #3: Analyzing Open-ended Questions (about 1 hour)

a) Motivation: "Many of you have commented on some of the problems with a multiple-choice test. So let's see how students respond to open-ended conceptual questions. These questions were given to the students in the calculus based course as a pretest (during the first week of class) and as a posttest (during the first week of the second quarter). The responses you will be analyzing all come from the posttest. All responses are from students who passed the first-quarter course with an A, B or C grade.

The responses to these questions give you more information about how students are thinking than you get from the FCI or from grading the problem-solving tests. That is, what the students write is more like what they sound like when they work in groups in the lab or discussion sessions. So this will activity is good practice for beginning to develop your diagnosis skills. As a TA, you will have to listen to what students say, try to figure out what their conceptual difficulty could be, then think of a way to try to help them."

b) Activity #3: Explain task briefly (see page 31). Assign the following students to each group:

Group	Student #	Group	Student #
1	5	8	12
2	6	9	13
3	7	10	14
4	8	11	15
5	9	12	16
6	10	13	5
7	11	14	6

Have students **rotate roles**, and remind them to work on the group functioning goal they set at the end of Activity #2.

c) Closure: Call on students for answers to each question, and discuss.

Show overheads of posttest results (handout). (OVERHEADS)

The data for the algebra-based course was collected from one section in 1993. In this section, conceptual understanding was emphasized through the explicit teaching of a problem-solving strategy that emphasized the qualitative

analysis of context-rich problems before the mathematical solution. The students solved problems in cooperative groups in both discussion sessions and labs.

The data for the 1993 calculus-based course data was collected by randomly selecting about 33 students from each of three different sections of the course. One section was taught in a traditional manner. The other two sections used group problem solving in discussion sections, but no explicit problem-solving strategy was taught.

The 1996 calculus-based course data was collected at the beginning of spring quarter in one section of the calculus based course. 71 students had the same instructor using the full model (explicit teaching of a problem-solving strategy plus cooperative group problem solving) for two quarters. 85 students had transferred into the course from other sections that used group problem solving in discussion sections, but no explicit problem-solving strategy was taught.

These results support the findings of McDermott's Physics Education Group at the University of Washington: "The use of the word 'force' and other technical terms is ambiguous and unstable. . . the underlying conceptual problems were complex and could not be adequately summarized as a simple belief in the necessity of a force in the direction of motion."

**DAY #2 MORNING AND AFTERNOON:
 Demonstration of Recitation Section, Rationale for Lab and Recitation
 Structure, and Problem Solving
 (about 3.5 hours)**

Weds 8/25	<p>Morning: How are discussion sections taught at UofM? Why?</p> <p>What difficulties do students have solving problems?</p> <p>Activity #4-6</p> <p>Afternoon: What difficulties do students have solving problems (cont)?</p> <p>Activities #7-8</p>	<p>Readings: Booklet -- Labs and Cooperative Grouping</p> <ul style="list-style-type: none"> • Martinez — What is Problem Solving (4 pages) • Larkin — "Processing Information..." (3.5 pages) • Heller, Keith, & Anderson — Teaching problem solving through cooperative grouping. Part 1 (9 pages) <p>Instructor's Handbook — Teaching a Discussion Session</p> <ul style="list-style-type: none"> • General Plan for Discussion Sessions (1 page) • Detailed Advice for Teaching Discussion Sessions (4.5 pages)
--------------	--	--

Activities

1. Activity #4: Demo discussion/bad presentation demo?
2. Activity #5: Coop. vs. Trad. Recitation Sessions (OVERHEADS)
3. Activity #6: Problem Solving: Expert vs. Novice
4. Activity #7: PS Strategies, PS in lab
5. Activity #8: Practice using a PS Strategy

Handouts: GWE problem
 GWE solution
 Butcher paper
 New pages 61, 66, 73

Preparation:
 New groups for today

Activity #4: Demo of Discussion Section Instruction (about 1 hour) Vince

Vince: Teaches discussion session exactly like he would teach undergraduates, excepts TAs solve a GWE problem. (Also bad presentation demo?)

Activity #4b/5: Rationale for Lab and Discussion Section Structure (about 30 minutes) Pat and Ken

1. Discuss overheads of survey of Engineering Departments: Goals & Topics -- why we emphasize using concepts and principles to solve problems. (OVERHEADS)
2. Discuss overheads of "The Dilemma" (page 55 of Activities Booklet) -- why we use cooperative group problem solving.
3. Show overheads of survey of desired structure for discussion and lab sessions. Emphasize the similarities between discussion and lab.
4. Answer any questions students have about lab or discussion session structure.

Activity #6: Differences in Expert-Novice Problem Solving (about 1.5 hrs) Pat and Ken

- a) Motivation: "Your responsibilities as a TA include tutoring students who are having difficulty solving the homework problems during office hours, as well as "coaching" students as they solve problems in both the discussion section and the lab. To be an effective tutor and coach, you need to know (1) some common difficulties that students encounter solving problems, and (2) how to diagnose these difficulties from what they say and what they write, and (3) how to help students with their difficulties. We will be spending the next few days on these topics.

First, let's have you solve a typical problem. Turn to page 59 of your Activities Packet and solve the Cowboy Bob problem as quickly as you can."

- b) In the next activity, you are going to compare how you solved the Graduate Written Exam problem earlier this morning with how you solved the Cowboy Bob Problem, and how a beginning student solves the Cowboy Bob problem.

You are going to make a flow chart of how you solve real problems." Show overhead of flow chart for starting a car in the winter. (OVERHEAD)

- b) Activity: Assign new groups (roles by latest birthday).

Hand out new Activity 6b. Have TAs turn to Activity Sheets (pages 61-66). Explain task briefly. (**NOTE: TAs MUST GET FLOW CHARTS ON ONE PAGE, and sign sheets.**)

After TAs start, hand out butcher paper & marker to each group.

- c) Closure: Have TAs examine flowcharts. Discuss similarities and differences between steps when solving real problems and when solving exercises, and discuss differences in expert-novice problem solving.

Larkin recommends teaching students to follow a problem-solving strategy. This leads into the next activity (Activity #7).

3. Activity #7a: Comparing Problem-solving Strategies (about .75 hour) Pat and Ken

Hand out new page 1 of Activity 7b (page 73).

The purposes of this activity are to (1) introduce TAs to different "explicit" problem solving strategies, and (2) to begin a discussion of how they can "coach" students.

- a) Motivation: "Jill Larkin recommended that students be taught an explicit problem-solving "strategy" that helps students learn the processes an expert goes through when they solve real problems (not "exercises"). There are now many problem solving strategies in the literature -- almost every textbook includes a problem-solving strategy now. So which strategy is "best?" Are the strategies very similar, or are there fundamental differences? How would following a strategy make it easier to coach students? To answer these questions, you will analyze two different strategies."
- b) Rotate roles, have students turn to strategies (pages 67-72), and explain task briefly: Groups should come up with three similarities and three differences between the two strategies.
- c) Closure: Call on groups to contribute a similarity or difference in strategies, and write on overhead.
- The major point is that the strategies are more similar than different when actually executed. They each use different words to describe similar processes, and they have slight differences in emphases, but they all require students to draw diagrams, define variables explicitly, break the problem into sub-problems that can be solved while keeping track of the unknowns. Discuss the different ways the authors suggest students plan a solution.

- It is also sometimes useful to return to the "chunking" idea. Writing was invented as a natural extension to short-memory, which for most people is between 4-7 "bits" of information. Experts have "chunked" many bits together, so they do not need to write as much -- they have enough short-term memory to solve the problem. But beginning students have not chunked, so each little step is one of their 4-7 bits. They soon run out of short-term memory space, and literally forget what they did before *if it is not written down*. This is one reason why the authors of all the strategies insist that students explicitly write down a lot of information that an "expert" could probably keep in short-term memory.

d) (OPTIONAL if we have the overhead) Pass out handout for Act. #7: Show overhead of Polya's strategy and compare with MN Plan Overheads. Then show overhead of sources of different strategies.

e) Finally, discuss the last question: How will knowledge of these strategies help you become a better problem-solving coach and grader?

(At some point, hopefully, someone will mention the technique of gradually moving from simple to more difficult problems. Sometimes TAs see the dilemma themselves -- simple problems reinforce the novice "plug-and-chug" strategy, while novices fail at the more difficult problems.)

Activity #7b: Methods Questions and Problem Solving (about 0.5 hrs) Pat and Ken

The purpose of this activity is to show TAs how the Methods Questions can "coach" students.

a) Motivation:

b) Activity: Rotate roles, have students turn to Activity Sheets (pages 73-78), and explain task briefly.

c) Closure: Call on groups to contribute which steps of the strategy in the Competent Problem Solver the Methods Questions "coach" students through.

d) Finally, discuss a last question: How will knowledge of the connection between the strategies and the methods questions help you become a better problem-solving coach and grader?

Act. #8: Practice Using a Problem-solving Strategy (about 45 min)

a) Motivation: "You can not help students with the steps they need to go through unless you can "unchunk" yourself, and begin to think about and write down a lot more information than you are used to. So in this activity, you can practice using a strategy to solve a problem from the algebra-based course."

b) Activity: Rotate roles, and have students turn to Activity Sheets (pages 79-82).

"Try to explicitly follow the roles assigned to you. When you teach the discussion sections, you will have students solve problems in cooperative groups and you will also assign roles. So try to follow the roles to experience what it feels like in a problem solving situation."

c) Closure: Briefly discuss how difficult it was for them to follow the strategy and the roles. Did it help to have the manager read the steps?

**DAY #3 MORNING AND AFTERNOON: Demo Lab
and Prepare for Peer Teaching (about 6 hours)**

<p>Thurs 8/26</p>	<p>Morning: How are the labs taught at the U of M?</p> <p><i>Activity #9</i></p> <p>Afternoon: Preparation for peer teaching of labs.</p> <p><i>Activity #10</i></p>	<p>Reading: Booklet — Problem Solving</p> <ul style="list-style-type: none"> • Toothacker — A critical look at lab instruction... (3.5 pages) <p>Readings:</p> <ul style="list-style-type: none"> • FAQ About the Labs (7 pages) • General Plan for the Labs (1 page) • Detailed Advice for Teaching Labs (4.5 pages) <p>Homework #2:</p> <ul style="list-style-type: none"> • Read Appendix G: Lab Prep Programs (5 short pages) • Read Appendix E: Video Analysis of Motion (5 short pages) • Read: How to access lab prep programs (2 pages) • Read your assigned Lab (intro., problems) in SLM • Skim the relevant sections of textbook • Answer predictions and methods questions for all problems in the assigned lab
-----------------------	--	---

Activities

1. Activity #9: Demo lab
2. LUNCH
3. Discussion of labs/ introduce peer teaching (OVERHEAD)
4. Activity #10: Peer teaching data collection

Handouts:

Preparation:

New groups for demo lab
Peer teaching groups

1. Activity #9: Demonstration of Lab (about 2.5 hours) Vince and Dave mentor Charles and Andy

(Page 83 in Activities Packet.) Teach one problem (1 hour), then switch rooms, and teach the other problem (1 hour). Break class into thirds; set each group to filling out the rationale on pages 84-88 for the beginning game, middle game, **or** end game (15-20 min.). Then come together and discuss entire rationale.

2. Discussion of Problem-solving Labs / Introduce Peer Teaching

1. Have students turn to page 26 of Instructor's Handbook (Table of Lab Comparisons). Explain that our labs are designed to support the major goal of the introductory courses -- to help students use concepts and principles to solve problems. So our instructions are somewhere between traditional verification labs and inquiry labs -- enough guidance so groups can figure out what to do with minimal help from the instructors, but NOT "cookbook" labs.

Show Tom's overhead -- students think guidance about right.

2. Have students turn to Flow Chart in Instructor's Handbook (page 29). Explain difference between Problem and Exploratory Problem. (This morning they did one of each.)
 3. Answer any questions students have about lab.
 4. Explain *briefly* Activity #10 (page 89). Tell TAs that their group will be assigned 2 lab problems and they will need to choose or write a recitation problem. All 3 members of the group must prepare for all 3 problems, since they will not know which one they are teaching until the day they teach. This means all 3 must have data for the lab problems, and they also must have solutions for the recitation problem ready. The Instructor's Handbook is a good source of problems to choose from.
- 3. Activity #10: Collect data for peer teaching. TAs make predictions, collect data, choose recitation problem.**

**DAY #5 MORNING:
Designing Problems, Typical Objections,
and Intervening in Groups (about 3.5 hours)**

<p>Mon 8/30</p>	<p>Morning: Discuss Homework.</p> <p>What are the characteristics of good group problems?</p> <p>What are the best ways to "coach" students while they are working in groups?</p> <p><i>Activities #11-13</i></p> <p>Afternoon: Practice teaching Lab II & Rec II.</p>	<p>Readings: Booklet — Cooperative group problem solving</p> <ul style="list-style-type: none"> • Collins, Brown, & Duguid — Situated Cognition and the Culture of Learning, pages 32 & 37-42 (7 pages) • Heller & Hollabaugh — Teaching problem solving through cooperative grouping, Part 2, section III (pages 638 - 640, 2.5 pages) • Heller & Hollabaugh — Teaching problem solving through cooperative grouping, Part II, pages 640-644 (4 pages) [OPTIONAL] <p>Instructor's Handbook — Group Problems</p> <ul style="list-style-type: none"> • Characteristics of Good Group Problems ... (2 pages) • Cooperative Group Problem Solving (8.5 pages) <p>Homework #4: Solve Context-rich Problems</p> <p>Homework #5: (due in the afternoon):</p> <ul style="list-style-type: none"> • Read 1301 Lab II in SLM • Skim the relevant sections of textbook • Answer predictions and methods questions for problems • Pass the computer lab prep program. <p>OR Peer Teach</p>
---------------------	--	---

Activities:

5. Discuss Homework
6. Activity #11: Designing a group problem
7. Activity #12: Typical Objections
8. Activity #13: Intervening in Groups
9. Assign reading about judging problems too! (Pages 49-52 in Instructor's Handbook)

Handouts:
Butcher paper

Preparation:
New groups for today

Discuss Homework: How did TAs like solving the problems using the strategy?

Activity #11: Designing a Group Problem (about 1.5 hours)

a) Motivation/Introduction: "You may be asked by your professor to either construct a first draft of a group problem (in teams of two), or to critique a draft of a problem the professor developed. It is very difficult to design a good group problem. It turns out that you can not just use a standard textbook problem."

Show the first overhead (see page 93) and elicit some responses from the TAs. This is a review of the Heller and Hollabaugh (1992) article. Then show overheads about appropriate group tasks (overheads #2 and #3 on page 94).

Show Overhead #4 (page 95). Ask the TAs why this version of the textbook problem is a better group problem. Discuss. Then show Overheads #5 and #6 (page 96).

Show Overhead #7 (page 97) and ask the TAs to list which of the five characteristics of a context-rich problem are missing from this textbook problem. Discuss. Then show Overhead #8 (page 98), which is the context-rich version of this textbook problem

Repeat this process for Overheads #9 & #10 and Overheads #11 & #12 (pages 99-102). "So now let's try to design our own group problem from a textbook problem."

b) Have students turn to the Activity Sheets (see page 103-108), assign roles, and briefly explain the task: first have the TAs read the Instructor's Handbook section on creating context-rich problems (pages 104-107 in Activities packet), then the TAs are to start with a textbook problem and turn it into a context-rich problem. Each context-rich problem should be written on a large sheet of paper and taped to a wall. Be sure to assign the same problem to at least three groups, so the TAs can see the same physics applied to different contexts.

c) **Closure:** After the groups have put their context-rich problems on the walls, have the TAs walk around and read each problem. The groups take turns giving one "piece of advice" to another group about how to make their problem better.

Activity #12: Typical Objections to Cooperative-Group Problem Solving (about 1 hr)

a) Motivation: "You have been reading about and we have just discussed some of the reasons we decided to use cooperative-group problem solving at the Univ. of MN. When we learn a new teaching technique, there is a tendency to focus on the disadvantages of the new technique -- we forget that all techniques, including the traditional techniques with which we are comfortable, have disadvantages. In this activity, you will have an opportunity to compare some common objections to cooperative-group problem solving with the analogous objections to traditional recitation sections."

b) "What do we mean by a traditional recitation section?" On a blank overhead, brainstorm some of the characteristics to "get the picture."

c) Activity: On overhead, show and model by thinking out loud the analogous objections to #1 and #5. Then turn to page 111 and try to do #7 together as a whole class (don't accept ideas that are not analogous objections).

Turn to page 109 -- explain task, have students rotate roles and start.

As groups start working, give each group a blank overhead of one objection to complete (8 remaining objections for 8 groups).

d) Closure: Call on groups to present analogous objections -- get other possible analogous objections from other groups. (If short on time, be sure to do #3, #8, and #9.)

e) If there is time, have TAs brainstorm other possible objections to cooperative group problem solving.

"The major point is that you can't reach all of the students all of the time, regardless of the instructional technique. The research indicates that cooperative groups have the advantage of reaching more of the students more of the time than traditional lecture methods."

Answer Key:

1. Instructors can not get inside students' minds to see if they are forming alternative conceptions.
2. Some students already know how to solve the problem that is being done on the board. So there is a lot of wasted time.
3. Some students do not ask questions, have not prepared, or are not thinking about the material.
4. You are only answering one student's question, so you don't address the concerns of the other students in the class.
5. The amount covered depends only on how fast the instructor can speak or write. It does not require real time intellectual engagement of the students.
6. Traditionally the weaker students get left behind and the best students are bored.
7. The research indicates that traditional instruction tends to only teach to about the top 15% - 20% of the class. See Claim #7 in Wandersee et. al. (1994) in the reading packet.
8. Lecturing is not teaching because you are concentrating on what **you** say and do instead of concentrating on what your students think.
Recitations are egotistical and authoritarian (i.e., teacher-centered) by nature.
9. Traditional recitations are authoritarian because everyone must interact only with the instructor and must think like them to follow their solutions.
10. Students are bored by being forced to play the role of listener.
11. Students do not want to go to a recitation section which rarely addresses their problem in understanding the concepts. Questions of other students are either so "advanced" that they can't follow or so "simple" that they are bored.

Act. #13: What Do You Do Next? Intervening in Groups (about 1 hr)

The major purposes of this activity are to (1) have TAs realize that they **can** and **should**, at times, intervene in a group to help it function better, and (2)

give the TAs a few "one-liner" responses (rationales) for students in some typical situations.

a) Motivation: In both the lab and discussion sessions you will teach, you need to monitor groups and intervene when necessary. In this activity, you will be presented with typical cases and asked "What would you do next?"

b) Activity: Have TAs turn to page 113. Explain task briefly.

After groups start working, pass out overheads with assigned situations.

c) Closure: Have one member from each group come up and present their group's scenario of what they would do next.

"The major point is that there is no 'one right answer' in the way to intervene or respond. So much depends on the context of the situation, your personality, and the students' personalities."

**DAY #6 MORNING:
Writing-Intensive Lab Reports (about 3.5 hours)**

Tues 8/31	<p>Morning Discuss Homework.</p> <p>Evaluating lab reports: Physics & Writing</p> <p><i>Activity #14</i></p> <p>Afternoon: Practice teaching Lab III & Rec III.</p>	<p>Readings: Booklet – Labs and Problem Solving</p> <ul style="list-style-type: none"> • Allie et. al. Writing Intensive Laboratory Reports (6 pages) <p>Homework #6: Use criteria to judge problems</p> <p>Homework #7: (due in the afternoon):</p> <ul style="list-style-type: none"> • Read 1301 Lab III in SLM • Skim the relevant sections of textbook • Answer predictions and methods questions for problems. • Pass the computer lab prep program. <p>OR Peer Teach</p>
--------------	---	---

Activities

1. Discuss homework: judging problems
2. Activity #14: Lab Reports

Handouts:

Lab reports
Article by Dr. Kastman?

Preparation:

New groups for today

Discuss Homework: Review the judgments made by the TAs and discuss any large discrepancies between their judgments and ours. (Need overheads of judging criteria.)

One factor that can lead to discrepancies in judgment is the tendency of some TAs (particularly foreign TAs) to solve the problems in sophisticated ways that students in introductory courses would not use. For example, problem #1 (Oil Tanker Problem) is rejected by some TAs because it can be solved with one equation *in a moving frame of reference*. In fact, this problem is a difficult group problem for students who have just started to study linear kinematics in the first weeks of an introductory course.

Key to Decisions: These are the old ones – mentor TAs have new ones

Problem and Timing	Difficulty Rating	Decision
1. <u>Oil Tanker Problem</u> : Assume students have just started studying linear kinematics (i.e., the definition of average velocity and average acceleration).	Rating = 3 - 4 <ul style="list-style-type: none"> • more information • more than two subparts • assumptions needed • sim. eqs. or calculus 	Since this problem would be used at the beginning of the course, it would be a <i>very</i> difficult group test problem. It gives students practice visualizing a physical situation, drawing a coordinate diagram, and carefully defining variables.
2. <u>Ice Skating Problem</u> : Assume students have just finished studying the application of Newton's Laws of Motion.	Rating = 2 <ul style="list-style-type: none"> • difficult physics (Newton's third law) • vector components) 	This would make a good easy to medium-difficult individual test problem. Since students are finishing their study of Newton's Laws, it is too easy for a group practice or group test problem. (Note: It would be a very good group practice problem if students were just starting their study of Newton's Laws)
3. <u>Safe Ride Problem</u> : Assume that students have just finished studying forces and uniform circular motion.	Rating = 4 <ul style="list-style-type: none"> • difficult physics (circular motion) • no explicit target variable • vector components • trig. to eliminate unknown 	This would make a good group practice or test problem. It could also be used as a difficult individual test problem.
4. <u>Cancer Therapy Problem</u> : Assume students have just finished studying the conservation of energy and momentum.	Rating = 3 <ul style="list-style-type: none"> • unfamiliar context • vector components • sim. eqs. or calculus 	This would make a good group test problem. The algebra is too long/complex for a group practice problem. It could also be used as a difficult individual test problem.
5. <u>Kool Aid Problem</u> : Assume that students have just finished studying calorimetry.	Rating = 4 - 5 <ul style="list-style-type: none"> • more than two subparts?? • no explicit target variable • more information • missing information • assumptions needed 	Given the number of decisions that need to be made and the missing information that needs to be supplied, this would make a good group test problem. It is probably too "difficult" for a group practice problem (i.e., it would take students more than 25 minutes to discuss and solve) . It would make a very difficult individual test problem.

Activity #14: Physics and Writing Errors in Students' Lab Reports (*about 2 hours*) **Ken**

What are we doing here?

**DAY #7 MORNING:
Diversity and Gender Issues (about 3.5 hours)**

<p>Weds 9/1</p>	<p>Morning: How can you teach for Diversity and personal interactions? What to do about cheating?</p> <p><i>Activities #15-16</i></p> <p>Afternoon: Practice teaching Lab IV & Rec IV.</p>	<p>Readings: Booklet — Sexual Harassment and Cheating</p> <ul style="list-style-type: none"> • Equal Opportunity Brochure, sections 1-10 (15 easy pages) • Shymanksy et al — Do TAs exhibit sex bias? (3 pages) • Seymour — Gender differences in attrition rates (9 pages) • Standards of Student Conduct — Sections IV and V (3 small pages) <p>Activity #16 - Read Case Studies</p> <p>Homework #8: (due in the afternoon):</p> <ul style="list-style-type: none"> • Read 1301 Lab IV in SLM • Skim the relevant sections of textbook • Answer predictions and methods questions for problems <p>OR Peer Teach</p>
---------------------	--	--

Activities

1. Activity #15: Cheating
2. Activity #16: Case Studies

Handouts:

Activity #15: Cheating (about .75 hours) Vince, Dave, Andrew, Laura

Show classroom climate overhead (page 117) and discuss.

Go through scholastic dishonesty “quiz” on page 118 and discuss answers - hopefully everyone will agree that they all are true!

Show overheads of cheating (page 119) - what is cheating? How can we reduce cheating in our classes?

Activity #16: Case Studies (about 1.25 hour) Vince, Dave, Andrew, Laura

Assign groups and four case studies to each group. Have groups discuss their four, then go on to the others if they have time. Bring whole class together for discussion of each case. Remember, there are no right answers, just different ways of dealing with each of these.

Day 6 Lesson Plan

TA Duties

Our TA Orientation is a 3-credit (about 30-hour) course called CI 5540: Teaching Introductory College Physics. The course meets during the two weeks just before our academic year begins, and all new TAs must complete this course. The goals and syllabus for the course are included on pages 13-17.

We have found that our new graduate students, who come from many different kinds of institutions both here and abroad, are anxious about their new role as teaching assistants (TAs). They tend to be success-oriented students, but they are also very unsure of themselves. Many have no conception of what they will be asked to do as a teaching assistant. Consequently, on the first day of the course they need to be told:

- (a) the structure of the introductory courses they will teach (e.g., page 4);
- (b) what the students are like in these courses (e.g., page 5);
- (c) the structure of the TA Orientation e.g., page 6 and 13-17); and
- (d) what their responsibilities and duties will be as TAs (e.g., pages 7-12).

We found, however, that it is important not to overwhelm them with too much information. Other important topics, such as professionalism, policies for cheating and sexual harassment, as well as how to teach non-traditional and disabled students and cultural sensitivity are best dealt with during a later session near the end of the course.

We have also found that the new TAs learn more and like the course better when it is structured around their teaching duties (e.g., teaching the labs, teaching the discussions sessions, etc.). So we embed the theory and research on learning and teaching within activities that center around their teaching roles.

Finally, we have found that it is important to teach the course by modeling the instructional techniques you want the TAs to use in their own teaching. At the University of Minnesota, our discussion sections and problem-solving labs are taught using cooperative grouping. Consequently, most of the activities in this course are taught using cooperative grouping techniques.

Introduction

What is a TA?

**What is your image of a teaching assistant (TA)?
What would you see a TA doing? What are their
duties and responsibilities? Who does a TA
work with? etc.**

Formulate an answer individually.

Share your answer with a partner.

Listen carefully to your partner's
answer.

Create a new answer through
discussion.



Notes: _____

TA Orientation and Seminars

Introductory Physics Courses

LECTURES

Three hours each week (Monday, Tuesday, Wednesday), sometimes with informal cooperative groups.

DISCUSSION SECTION

One hour each Thursday -- groups practice using a logical strategy to solve (context-rich) problems.

LABORATORY SECTION

Two hours each week -- *same* groups practice using strategy to solve concrete experimental problems.

TESTS

Friday -- usually a problem-solving quiz every two weeks; sometimes multiple-choice exercises and conceptual questions alternate weeks.

Learning Modes



Component	hours/week	Mode
Lecture	3	Individual
Recitation/Labs	3	Cooperative groups
Study/Homework	7 - 8	Individual

23% of course time spent in cooperative groups



TA Orientation and Seminars

Physics 1101 - 1102

Two-semester, algebra-based course for non-majors

Majors:

Architecture	45%
Health/Medical	25%
Physical Therapy	
Dentistry	
Pharmacy	
Chiropractic	
Medical Tech.	
Veterinary	
Agriculture/Ecology	10%



50% women
 50% had calculus
 50% had HS chemistry
 50% had HS physics

30% freshmen
 30% sophomores
 30% juniors
 10% seniors

Physics 1301-1302

Two-semester, calculus-based course for engineers and scientists

Majors:

Engineering	75%
Physics/Ast.	5%
Chemistry	6%
Mathematics	5%
Biology	9%



79% male
 80% had calculus
 87% had HS Physics

64% freshman
 22% sophomore
 10% juniors

61% expect to get an A
 53% work (25% more than 10 hrs/week)

TA Orientation and Seminars

TA Orientation Course

	Hours in Class
1. Introduction	3
✦ Course structure, students & TA duties	
2. Alternative Conceptions of Students	7
3. Teaching the Problem-solving Labs	
✦ Demonstration Lab	3
✦ Peer Teaching of Labs	12
4. Teaching the Discussion Sessions	
✦ Teaching Discussion Sections	5
✦ Student Difficulties with Problem Solving	1
✦ Characteristics of Good Problems	3
5. Professionalism and Diversity Issues	3
	37

Teaching Seminars

Mondays -- Fall and Spring Semester

	Hours in Class
1. Alternative Conceptions and Lab Preparation	9
2. Problem Solving	4.5
3. Grading and other Issues	4.5
	18

You will sign up for 1 credit in the Fall, and 2 credits in the Spring semester.

You will not receive a grade for the course until the end of Spring term (grades recorded as "I" until the end of Spring term).

TA Responsibilities

Description of Specific Duties

Most teaching assistants (TAs) will be assigned to a teaching team responsible for one of the introductory physics courses. Your most likely assignment is the first term of the calculus-based course since that serves the most undergraduates. A teaching team typically consists of one faculty member and four to five TAs. This team is responsible for all aspects of the course for about 140 undergraduates.

If you have a 25% appointment, you will be teaching one discussion session and one lab, with the same students (less than 20) in your discussion session and your lab. If you have a 50% appointment, you will be teaching two discussion sessions and two labs, with two sets of students. Discussion sessions meet for 50 minutes on Thursdays, and labs meet throughout the week for 2 hours at a time.

Teaching Discussion Sections:

Try to get to your assigned classroom several minutes early. If possible, you should be there before most of your students. You may need to tidy the classroom, clean the blackboard, rearrange the chairs, and/or write on the blackboard (i.e., the agenda for class, groups students should work with, or other announcements). Well before the first class, check out the room to see if it is appropriate for a discussion section. If it is not appropriate, tell the undergrad office and we will try to get it changed.

Teaching Laboratory Sections:

Make sure you get to your laboratory room at least 5 minutes before class starts, and do not let the students enter until you are ready. Use this time alone to check the apparatus to make sure that it is all there, it is neatly arranged, and it is in working order. If you are teaching a computer lab, you should check to make sure the computers are working properly. Any other quiet time can be used to make final preparations. Make sure the door is locked and the lab is in order before you leave.

Office Hours:

Office hours will be held in the Physics and Astronomy Drop-In Center, in Physics 140. This is your chance to interact one-on-one with your students, and it is your students' chance to get some personal tutoring. You will have one office hour a week for each of your sections.

Preparation for Laboratory:

- You will only have a new laboratory to teach every two-three weeks. You should become very familiar with the equipment, and consult the Instructor's Lab Manual and experienced TAs to find what might go wrong with it or what kinds of mistakes students might make. If you can, it is a good idea to observe someone else's lab session before you teach yours. With your team, select which lab problems have priority.
- If you are continuing a lab you have already started, you should decide which groups should do which lab problems at the next lab meeting.
- You will also want to solve all predictions and method questions that you have assigned to your students. In the team meetings (and some All-TA meetings) you will discuss difficulties that students have had with the physics principles they need to do the lab.

TA Responsibilities

- Students will be using computer laboratory preparation programs before each new lab. You will be shown how to use a program to check whether they have attempted or completed their assigned programs before they get to lab. You should go through these questions before your students do. Dropping into the computer laboratory (room 130) from time to time to observe the students taking these tests and helping them out is a good opportunity to discover some of their physics difficulties before they come to lab.
- Have a goal for each lab, something you want your students to learn. This should be decided in your team meetings after discussion with the professor and other TAs.

Preparation for Discussion Sections:

- Solve the group problem students will solve in discussion section. Discuss with your team what aspect of the problem you expect will be difficult for the students.
- Look at the syllabus and homework problems assigned for the week. Be prepared to tell your students which homework problems are similar to the group problem.
- In some sections, you may be asked to work with other TAs to design or write a group problem. You will present the first draft of your problem to your team for critique, and may be asked to write a second draft. This will occur once or twice a term.
- In some sections, you may be asked to choose the material for the discussion sections for some of the weeks. You may want to pool your skills and ideas with other members of your team, either during your team meeting or outside of it.

Team Organization Meetings:

Each week, the TAs and professors will meet as a team to discuss their course. Of course this is the opportunity to discuss the mechanics of the course (e.g., who will grade what, who will proctor, etc.), but the most important reason for the meetings is the communication between the different members of the teaching team. Important issues for this feedback are:

- The professor describing what is going on in lecture and why.
- Discussion about what to emphasize in the next discussion and lab sessions.
- Trading information and analyzing what students understand and do not understand. Since there can be a large diversity between the different discussion and lab sections, each TA should discuss and compare their section with other sections. This information is an invaluable input for the professor(s), who do not have the close contact with students that you do.

It is important that you take an active role in these team meetings.

Meeting with Mentor TAs:

You will each have a half hour appointment with your mentor TA each week. These meetings are to provide you with coaching to become better teachers. You might ask about problem students, difficulties grading, classroom management, course organization, or discuss other things that the mentor may have noticed in your section. Feel free to bring up anything else that relates to being a TA.

Attending the All-TA Meeting:

Each week the mentor TAs will convene a lunch time All-TA Meeting for the TAs of the introductory physics courses. These meetings will include an informal time to talk about teaching plus some time for a more formal discussion on how to handle difficult situations such

as cheating and how to explain physics that has been difficult for students in the past. Since this meeting is optional, lunch will be provided by the Physics Department.

Grading Labs:

You will be grading written lab reports every two or three weeks. As with all grading, prompt feedback to the students is essential. The ten-point grading scheme is included in the Instructor's Lab Manual.

Grading Homework:

Different teams will make different decisions about how homework will be collected and graded. Whatever scheme you decide to use cannot take much of your time. Be sure to grade and return homework as soon as possible, so that students can use the feedback to get help.

Grading Tests:

- At this time, the estimate for how much time it takes to grade one of the more difficult problems is as follows:

$$(0.5 \text{ hr classifying}) + \left(\frac{140 \text{ probs}}{\text{quiz}}\right)\left(\frac{3 \text{ min}}{\text{prob}}\right)\left(\frac{1 \text{ hr}}{60 \text{ min}}\right) + (0.5 \text{ hr recording}) = 8 \text{ hrs}$$

On average, each TA will grade 3 such questions each term, plus one group problem (about 50 problems). This should average to less than 3 hours/week. In your team meetings you will arrange which TAs will grade which problems.

- After you spend the time classifying a subset of tests, it is estimated that a quiz problem will take, on the average, 3 minutes to grade. Obviously some student solutions will be extremely convoluted and some will be blank.
- After you have completed the grading, you will enter the grades into the computer (see FAQ: Entering Course Grades in this Handbook).
- Grading should be completed, graded and scores entered into the computer, by noon Monday if possible. It is important the students receive prompt feedback on all graded assignments.

Proctoring

You will all be asked to proctor the tests for your course. While proctoring, you are responsible for answering student questions and deterring cheating. The schedule for proctoring will be discussed in your team meetings.

Miscellaneous:

If you get a chance, it is highly recommended that you go to lectures. It is a good opportunity to see exactly what is happening, and it also shows the students that you think lectures are important.

Final Exams and Lab Grades:

Each TA will probably grade one or two final exam problems which will take about 8 hours each. This grading will occur, in most cases, after your last final exam so make sure that you plan enough time at the end of the term. In addition, you must be sure to have integrated your lab and homework grading into the course grading spreadsheet before the semester ends.

TA Responsibilities

Average Time/Week During the 14-week Semester

Often, TAs want to know about how much time they should be spending on different duties. Your **average** weekly load during the 14 weeks of class for a 50% appointment should be approximately that listed below.

Contact with Students:

2 Discussion Sections	2.0 hrs
2 Laboratory Sections	4.0 hrs
Office Hours	<u>2.0 hrs</u>
	8.0 hrs

Preparation:

Laboratory	1.0 hrs	
TA Seminar	1.0 hrs	Teams will decide how to
Discussion	1.0 hrs	structure this between team
Team Organization	<u>1.0 hrs</u>	meetings and individual prep.
	4.0 hrs	

Grading and Entering Grades:

Labs	2.0 hrs	(average)
Tests and Homework	<u>3.0 hrs</u>	(average)
	5.0 hrs	

Feedback and Support:

Meet with Mentor TA	0.5 hrs	
All - TA meeting	<u>1.0 hrs</u>	(optional)
	0.5 hrs	

Proctoring Tests:

1.0 hrs

Miscellaneous:

1.5 hrs

(dealing with the front office, helping students outside of office hours, etc.)

TOTAL 20.0 hrs/week*

* The University does not recognize the time between terms as holidays. Although the Physics Department typically does not assign TA duties after final exam grades are recorded, this time must be counted to compute your actual average hours worked per week.

Using Your Mentor TAs

Your mentor TAs each work 10 to 20 hours a week to help you improve the skills you need to become a better TA which will ultimately improve the undergraduate education in the physics department.

Specifically, the duties of the mentor TAs are to:

- be active instructors in the TA orientation in August.
- organize and moderate the weekly all-TA meetings in which we discuss:
 - teaching concepts relevant to the week's materials
 - problems with the previous lab
 - difficult students
 - your issues and ideas about teaching
- co-teach the seminar in the Fall and Spring in which we discuss topics similar to those in the all-TA meeting, and other topics including:
 - lab preparation
 - assigned readings
 - grading exams and homework
 - alternative conceptions your students may have
 - problem-solving strategies
- visit several of your labs and discussion sessions to:
 - observe your teaching techniques,
 - help you with intervening in groups,
 - give you feedback and answer questions about your teaching.
- report any unrescinded inappropriate behavior (i.e. behavior that is harmful to students) to the director of undergraduate studies.
- make recommendations for the TA award given at the end of the year.

If you ask them to, the mentor TAs will also:

- be resources for you in the physics department.
- serve as an anonymous conduit of your concerns to an individual professor or the department.
- help you find information in the education literature.
- help you write your lesson plans.
- help you find and practice with the laboratory equipment.
- advise you on grading, writing cooperative group problems, interacting with professors, and forming new groups.
- write teaching letters of recommendation.
- be willing to discuss the graduate school experience (both good and bad.)

Remember, like any instructional relationship, the mentor TA can provide you with ideas and suggestions, but the only impetus to improve your teaching lies within you.

Alternative Conceptions of Students

Related Readings:

McDermott, L. C. (1993). Guest Comment: How we teach and how students learn — A mismatch. *American Journal of Physics*, **61** (4) 295-98.

McDermott, L. C. (1984). Research on conceptual understanding in mechanics. *Physics Today*, **37**: 24-32.

Wandersee, J. H., Mintzes, J. J., and Novak, J. D. (1994). Research on alternative conceptions in science. In D. L. Gabel (Ed.), *Handbook of Research in Science Teaching and Learning*, New York: Macmillan.

Activities

We spend a full day (approximately six hours) introducing TAs to students' alternative conceptions in physics. TAs have read the above articles before they complete the following activities:

1. Introduction to Alternative Conceptions (page 21)
 - Activity #1a: Light Patterns (pages 23)
 - Activity #1b: Alternative Conceptions -- Light Patterns (page 37)
2. Alternative Conceptions in Dynamics
 - Activity #2: Analyzing the Force Concept Inventory (page 41)
 - Activity #3: Analyzing Open-ended Questions (page 53)

Instructor's Notes for Introduction to Alternative Conceptions (about 1.5 - 2.0 hours)

To introduce alternative conceptions of students, it is helpful to have TAs participate in an experience that makes them aware of their own alternative conceptions, and then have them reflect on the experience. There are many different activities you can use for this purpose. We use an adaptation of the Light and Shadow tutorial from *Tutorials in Introductory Physics* by Lillian C. McDermott and Peter Shaffer and the Physics Education Group, Department of Physics, University of Washington (Prentice Hall, 1998).

Introduction

Assign TAs to groups and have them discuss (1) how they learn best, and (2) some characteristics of good instruction (page 23).

Activity #1a: Light Patterns

- a) Motivation: "Before we begin, we are going to briefly illustrate some of the components of the instructional strategy we use at the University of Minnesota. You will be able to compare and contrast these strategies with what you consider to be good instruction and good conditions for learning. The focus of this short demonstration is the topic of light patterns. Here is the problem you will be focusing on. Please complete the prediction questions." Pass out the Light Patterns Problem and the Prediction questions (pages 24 - 27).
- b) Activity #1a: Have TAs go to lab room to complete the problem (see Activity Sheets, pages 28 - 36).
- c) Closure: Discuss the similarities and differences between the lab activity they just completed and "conventional" labs.

Activity #1b: Alternative Conceptions -- Light Patterns

- a) Motivation: Pass back the "predictions" to TAs. "Although you have all probably had formal instruction in optics, you probably all had some difficulty applying this knowledge to real situations (at least we all did when we went through a similar activity.) In fact, you may have used some intuitive 'alternative conceptions' to make your predictions."

- b) Activity #1b: Introduce the activity (page 37): “I would like you to take some time to reflect on the experience you just had, from making the predictions to completing the exploratory lab problem. Which of these knowledge claims made by Wandersee, Mintzes, & Novak (1994) did you *personally* experience in some way? (You may not have experienced all of these claims, but certainly the majority.) I'll give you the first one -- Claim # 6. Each of your instructors in this course standing before you now had some alternative conceptions about Light Patterns!”
- c) Closure: Have TAs share some of their answers.

Review what all the instructional strategies that promote conceptual change have in common (page 38)-- disequilibrium, intelligible, plausible, fruitful (from Posner, Strike, Hewson and Gertzog, 1982).

If there is time, review Claim #7 (Unintended Learning Outcomes) from the Wandersee et. al., (1994) article (pages 38 - 39). Discuss the implications for teaching introductory physics students.

**EXPLORATORY PROBLEM #1:
Light Patterns**

Because of your physics background, you have been asked to consult for the FBI on an industrial espionage investigation. A new invention has been stolen from a workroom, and the FBI is trying to determine the time of the crime. They have found several witnesses who were walking outside the building that evening, but their only recollections are of unusual light patterns on the side of the building opposite the workroom. These patterns were caused by light from the workroom coming through two holes in the window shade, a circular hole and a triangular hole. The room has several lights in it, including two long workbench bulbs. During the theft, the burglar hit one of the workbench lamps and broke the supporting wire, leaving it hanging straight down. Together with the other bulb, it forms a large “L” shape. Going outside, you see that the lamps do leave interesting patterns on the sidewalk. Your job is to determine, based on the light patterns the witnesses recall seeing, when the theft took place. You decide to model the crime scene in your lab using the equipment shown below.



What patterns of light are produced with different shaped holes and light sources?

EQUIPMENT

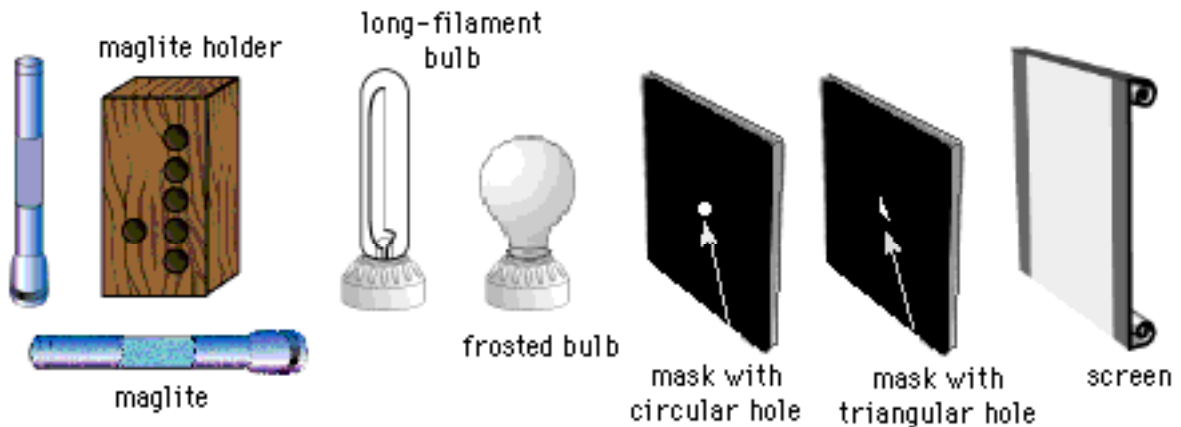

You will have: a maglite holder; two mini maglites; a clear tubular bulb with a straight filament mounted in a socket (representing a long workbench bulb); two cardboard masks, one with a circular hole and one with a triangular hole (representing the holes in the window shade); and a large white cardboard screen (representing the side of the building).

PREDICTIONS

1. Suppose you took a Maglite flashlight, took the cover off, and held it close to a card with a small circular hole in it. What would you see on the screen behind the card? Draw what you think you would see on the screen.

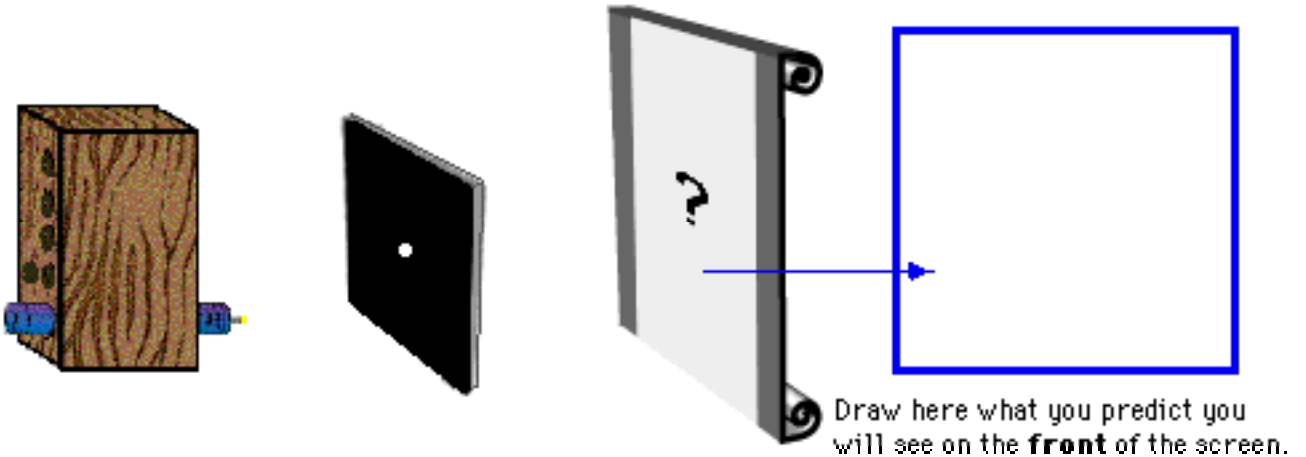

Explain your reasoning. Why do you think this is what you will see?

2. Now suppose you had a bulb with a long filament inside. Imagine you were to hold this near the card with a small circular hole in it. Draw what you predict you would see on the screen.

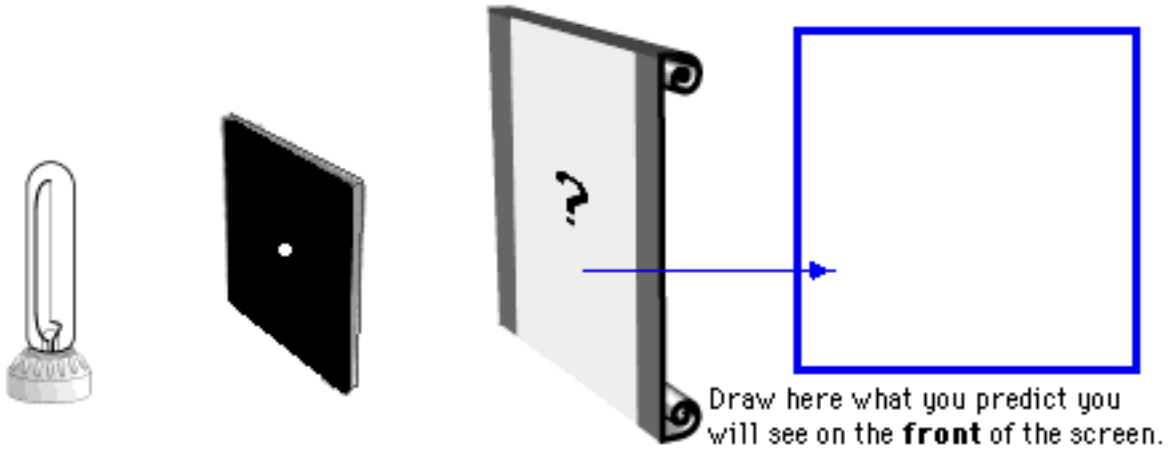

Why did you draw what you drew? Explain your reasoning.

3. Suppose you took two of the long filament bulbs and held them together to form an “L” shaped filament, and held this setup near a card with a small circular hole in it. What would you see on the screen? Draw your prediction.

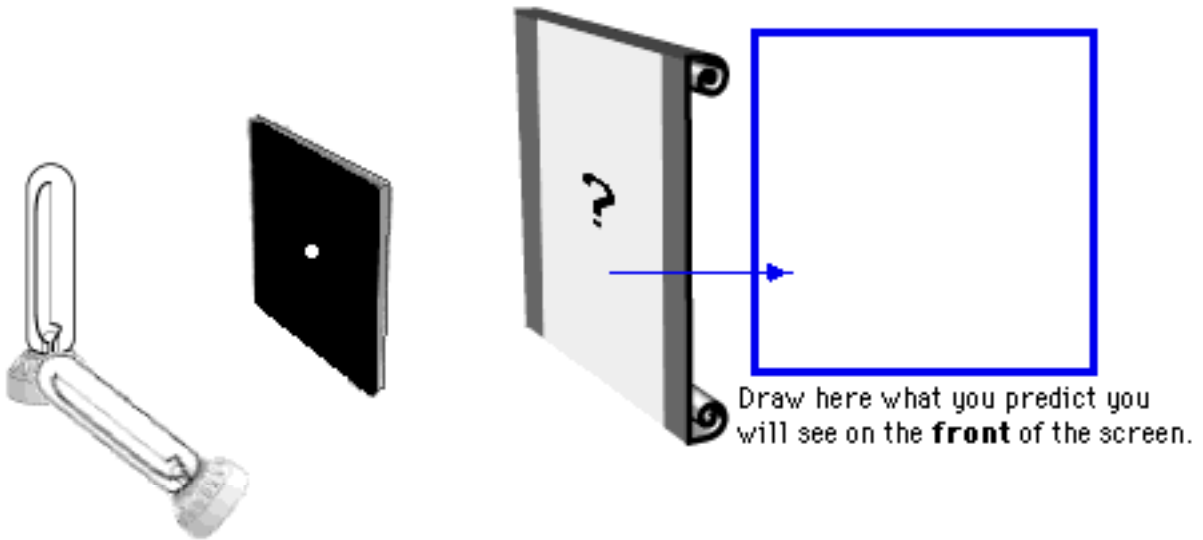

What was your reasoning?

4. Now imagine you kept the bulbs in the shape of an “L”, but now replace the hole in the card with a triangle instead of a circle. Predict what you would see on the screen, and draw your prediction.

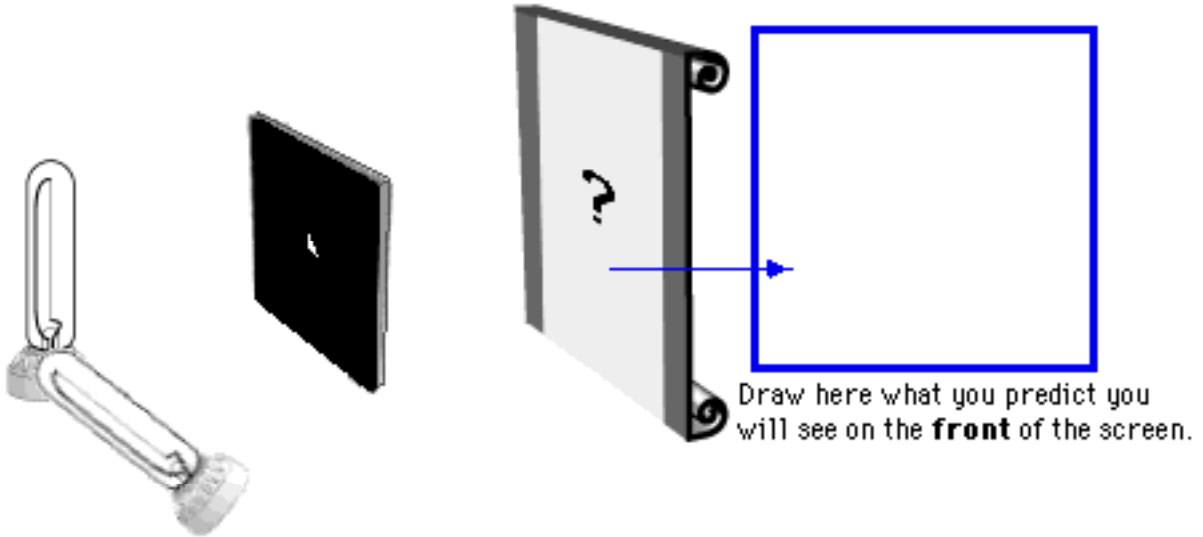

Explain your reasoning.

EXPLORATION

Before you tackle the complex problem, you decide to explore the different light patterns you can get on a screen when light from different kinds of sources shine through holes with different shapes.

1. Suppose you had a maglite, arranged as shown below, close to a card with a small circular hole. **Predict** what you would see on the screen with a lit maglite in a darkened room.

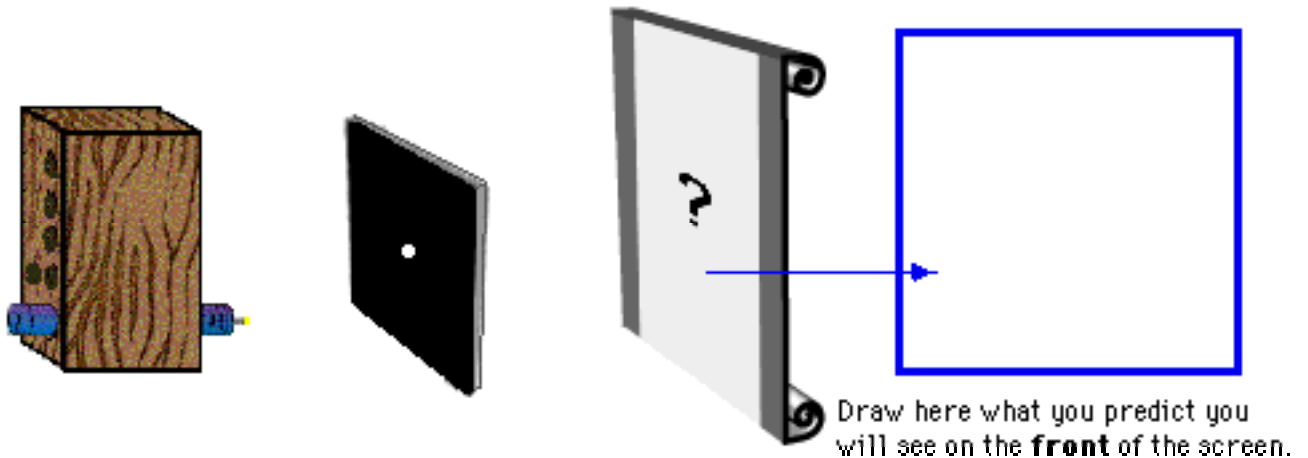

Explain your reasoning.

Predict how moving the maglite upward would effect what you see on the screen. Explain.

Test your predictions. Ask an instructor for a maglite. Unscrew the top of a maglite, and mount the maglite in the lowest hole of the maglite holder, as shown above. Place the card with the circular hole between the maglite and the screen.

If any of your predictions were incorrect, resolve the inconsistency.

2. **Predict** how each of the following changes would affect what you see on the screen. Explain your reasoning and include sketches that support your reasoning.

- A. The mask is replaced by a mask with a triangular hole.

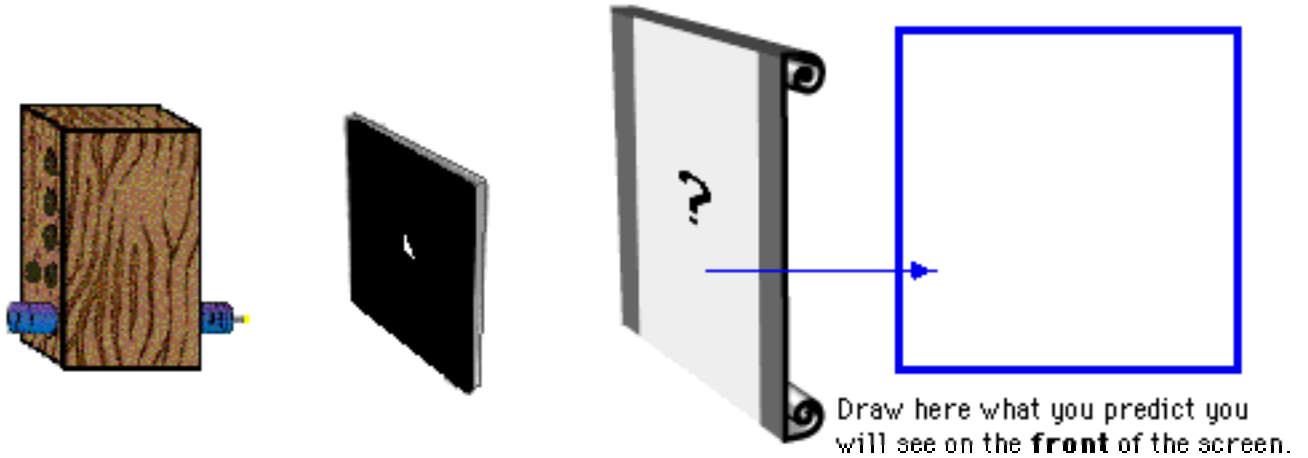

- B. The bulb is moved further from the mask.

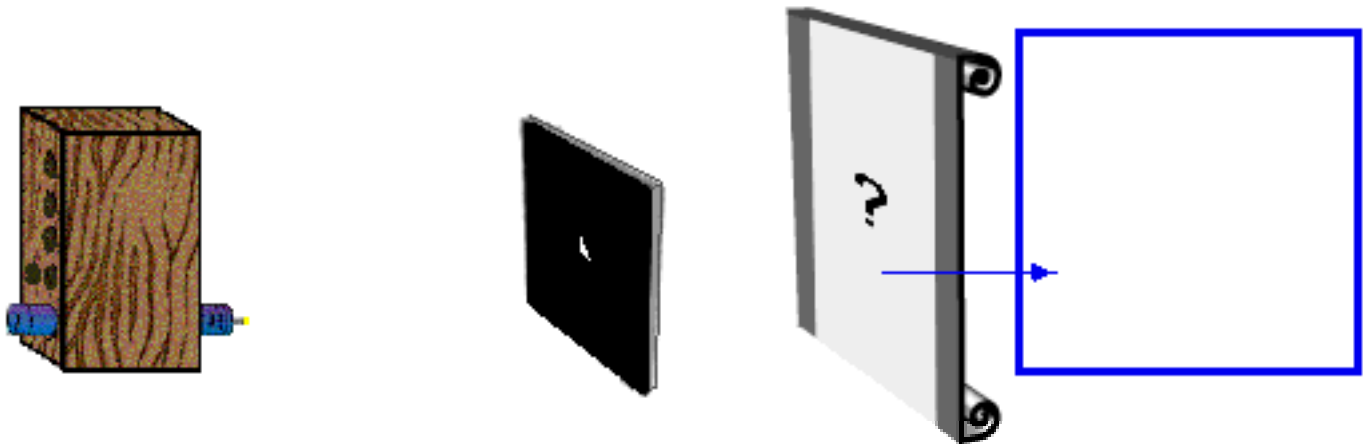

- C. **Test your predictions.** Ask your instructor for a card with a triangular hole, and perform the experiments. If any of your predictions were incorrect, resolve the inconsistency.

3. **Predict** how placing a second maglite above the first would affect what you see on the screen.

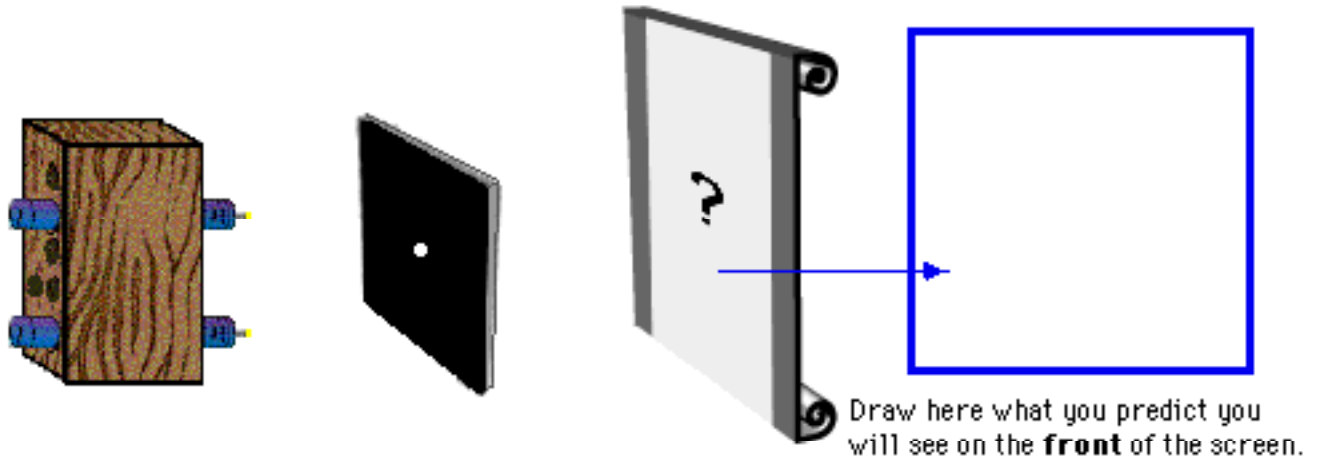

Explain your reasoni28 - the second maglite upward slightly would effect what you see on the screen. Explain.

Test your predictions. Ask an instructor for a second maglite, and perform the experiments. If any of your predictions were incorrect, resolve the inconsistency.

4. What do your observations suggest about the **path** taken by the light from the maglite to the screen?

5. Imagine that you had several maglites held close together, as shown below. **Predict** what you would see on the screen. Explain.

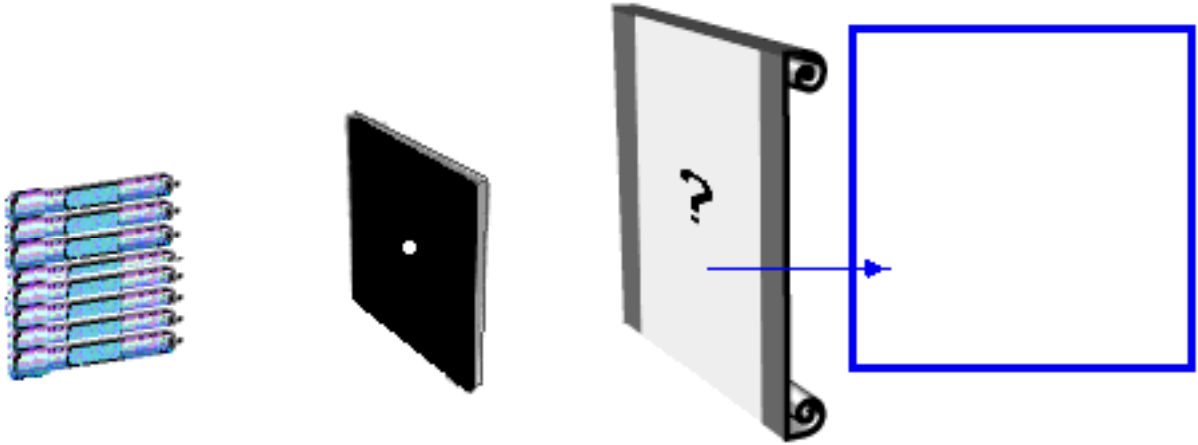

Predict what you would see on the screen if you used a bulb with a long filament instead, as shown below. Explain.

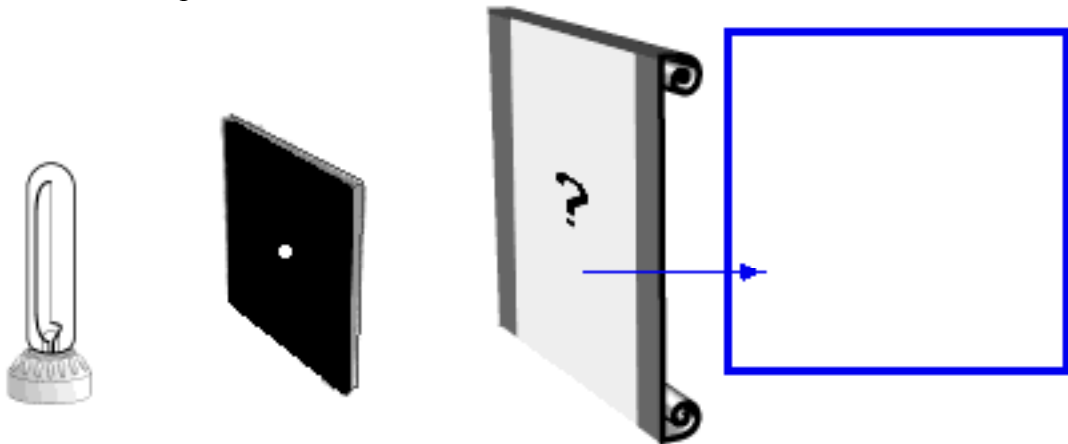

Test your predictions. Ask an instructor for a long filament bulb, and perform the experiments. If any of your predictions were incorrect, resolve the inconsistency.



6. **Individually predict** what you would see on the screen if you had both a maglite and a long filament bulb arranged side by side, as shown at right and below.

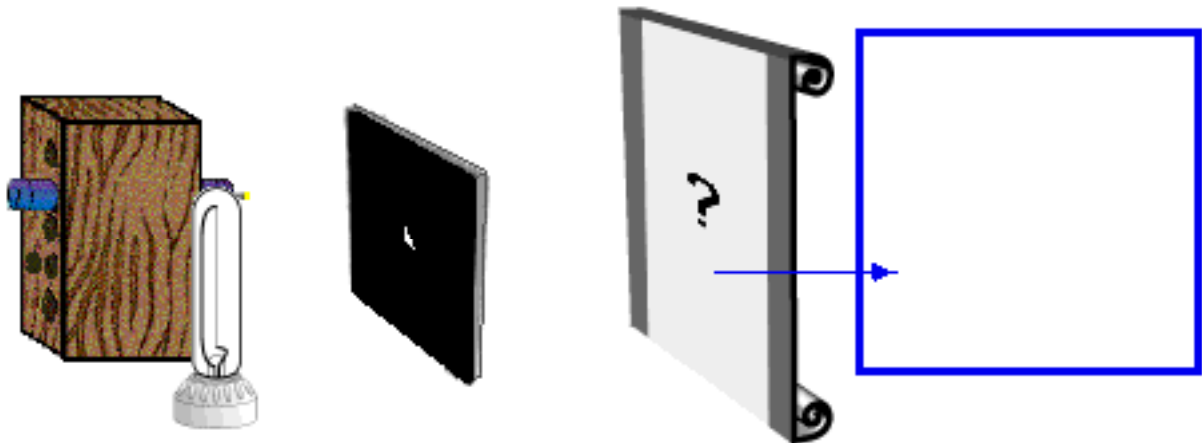

Explain your reasoning.

Compare your prediction with those of your partners. After you and your partners have come to an agreement, **test your prediction** by performing the experiment. Resolve any inconsistencies.

MEASUREMENT & ANALYSIS

You are now ready to investigate the light patterns that would be seen by the witnesses who passed the crime scene.

1. **Predict** what you would see on the screen if you had two long filament bulbs arranged as shown at right and below.

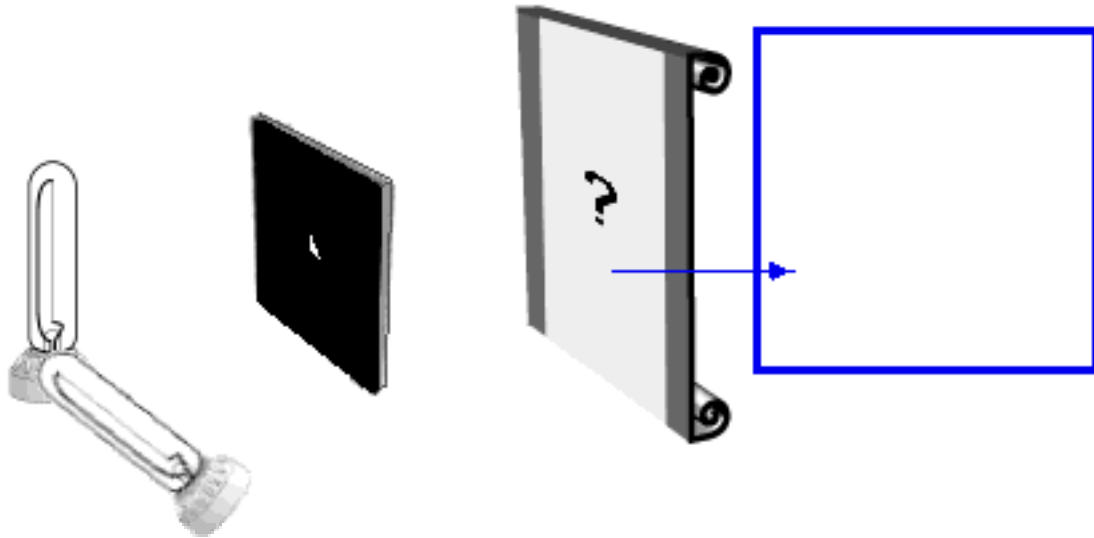
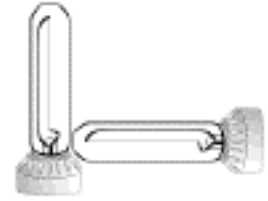

Predict what you would see on the screen if the mask were ~~removed~~.

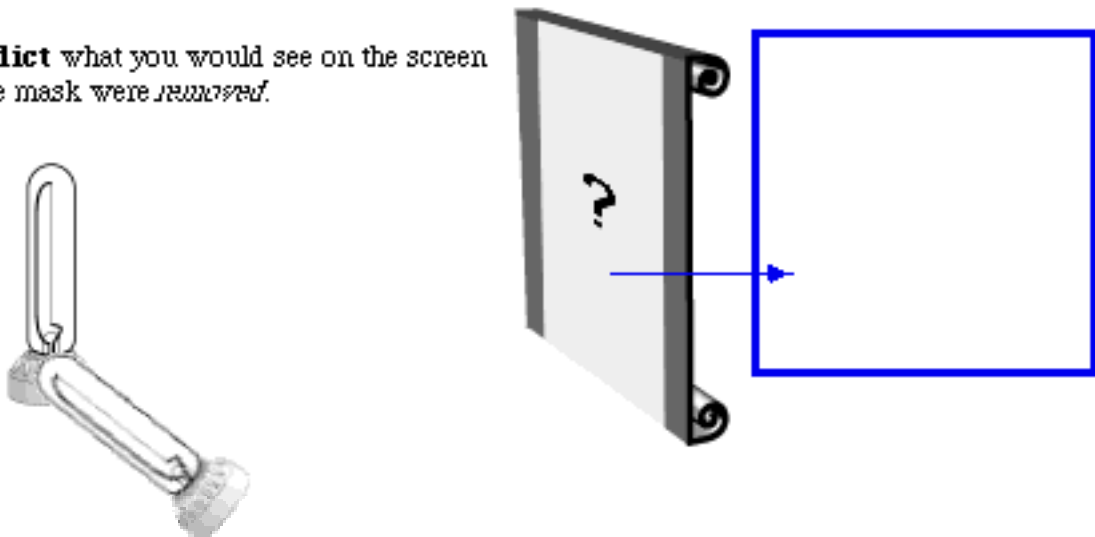

Test your predictions. Ask your instructor for a second long-filament bulb, and perform the experiments. If any predictions were incorrect, resolve the inconsistency.

CONCLUSION

What pattern would a witness see on the building wall from two horizontal lit bulbs through a circular hole and a triangular hole in the windowshade? What would a witness see when one bulb was horizontal but the other bulb was vertical? How would you determine the approximate time of the crime?

CHECK YOUR UNDERSTANDING

A mask containing a hole in the shape of the letter **L** is placed between the screen and a very small bulb of a maglite as shown below.

1. On the diagram below, sketch what you would see on the screen when the maglite is turned on.

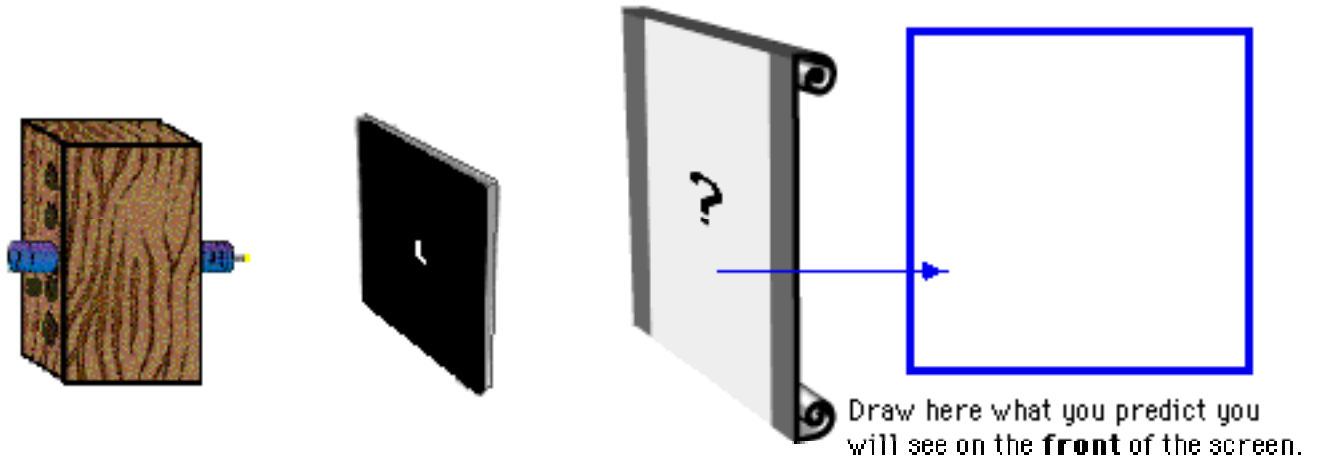

2. The maglite is replaced by three long filament light bulbs that are arranged in the shape of the letter **F**, as shown at right a below.



On the diagram, sketch what you would see on the screen when the bulbs are turned on.
Explain how you determined your answer.

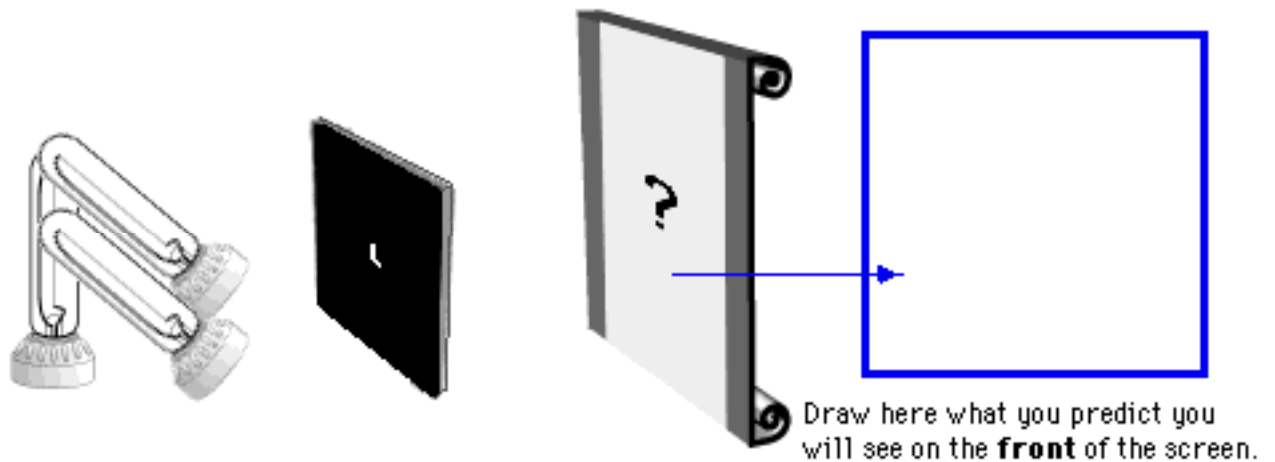

CHECK YOUR UNDERSTANDING

3 **Predict** what you would see on the screen when an ordinary frosted bulb is held in front of the mask with the triangular hole, as pictured below. Explain your reasoning..

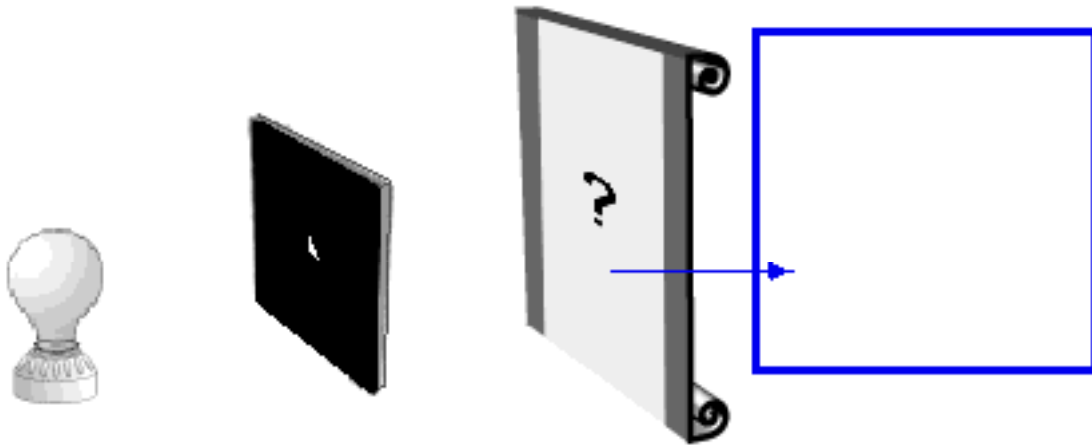

Alternative Conceptions -- Light Patterns

James Wandersee, Joel Mintzes, and Joe Novak (1994) describe several "knowledge claims" that have emerged from the research on students' alternative conceptions in the past 20 years. As you reflect on the activity, *Light Patterns*, describe briefly any examples you experienced of these claims.

Knowledge Claims	Examples from <i>Your Experience</i>
Claim 1: Learners come to formal science instruction with a diverse set of alternative conceptions concerning natural objects and events.	
Claim 2: The alternative conceptions that learners bring to formal science instruction cut across age, ability, gender, and cultural boundaries.	
Claim 3: Alternative conceptions are tenacious and resistant to extinction by conventional teaching strategies.	
Claim 4: Alternative conceptions often parallel explanations of natural phenomena offered by previous generations of scientists and philosophers.	
Claim 5: Alternative conceptions have their origins in a diverse set of personal experiences including direct observation and perception, peer culture, and language, as well as in teachers' explanations and instructional materials.	
Claim 6: Teachers often subscribe to the same alternative conceptions as their students.	
Claim 7: Learners' prior knowledge interacts with knowledge presented in formal instruction, resulting in a diverse set of unintended learning outcomes.	
Claim 8: Instructional approaches that facilitate conceptual change can be effective classroom tools.	

NOTES:

Instructor's Notes for Alternative Conceptions in Dynamics

Part a: The Force Concept Inventory

(about 1 hour)

Most entering TAs do not really believe the alternative-conceptions research results, particularly for students in the calculus-based courses. They believe that all students think and learn like they do. For those concepts they did not learn well, they believe the cause to be unclear or inadequate explanations. The purposes of this activity are to (1) begin to convince the TAs that the students **they will be teaching** have many conceptual difficulties, and (2) introduce the TAs to the way in which students in introductory courses "talk physics."

We have found that this activity is most effective for the TAs when we use actual results from students in the same course(s) for which they will be teaching assistants. We use data from pretest and posttest results from the Force Concept Inventory (Hestenes, Wells and Swackhamer, *The Physics Teacher*, **30**, 1992). We selected typical pretest and/or posttest questions and responses for our TAs to "analyze."

Since our TAs implement cooperative grouping techniques in both the discussion sections and labs, we model cooperative grouping throughout the TA Orientation. We follow the same general "rules" for forming and maintaining groups that we teach the TAs. For more details, see Heller and Hollabaugh, *American Journal of Physics*, **60**, 1992.

Activity #2: Analyzing the Force Concept Inventory

Note: For this activity to be meaningful, the TAs should have taken the Force Concept Inventory (FCI) themselves. We administer the FCI to the TAs on the first day of class. Then we record the results on a table with student results.

- a) Motivation: "As a TA, one of your responsibilities will be to monitor and diagnose students' conceptual difficulties so you can help them both during class, and in office hours. The first tool you will have available is the Force Concept Inventory (FCI), which will be administered to students during the first week of classes. You will use the results of the FCI to form your first cooperative groups in your discussion and lab sections."

Tell TAs how the FCI was constructed -- uses many questions first asked in interviews they read about in the assigned articles; authors checked responses by interviewing several students after they took the FCI.

Show the TAs the results for both themselves and the students in the calculus-based course (handout).

- b) Activity #2: **Explain** their group task briefly (See Activity #2, page 43). Every group should complete the question assigned to them first (see below), then go on to questions 19, 11, 15, 13, 17, and 4 in that order.

Group	Question	Group	Question
1	19b, c or d	6	19a
2	13b	7	13c
3	11b	8	11c
4	17a	9	17d
5	4a	10	15c

Introduce and discuss "roles" (see page 121).

Model how to complete this activity by thinking out-loud and writing the answers for the first FCI question (Question #30 on page 44) on an overhead.

While the TAs are working, assign a question to each group.

As the TAs finish the activity, give a **group processing sheet** to each group (see page 135).

- c) Closure: Randomly call on one person from each group to share their answers to a question.

Show and discuss the Hake Plot -- we are slowly making progress! Relate FCI results to the McDermott article. Many students do not have a "consistent conceptual system" -- their understanding and use of a particular concept like force is ambiguous and unstable, so the answers they give are strongly dependent on the context of the situation. If TAs are interested, discuss work by Andrea diSessa (pieces of knowledge called "primitives") and Jim Minstrell (pieces of knowledge called "facets").

Analyzing Force Concept Inventory Questions Group Task:

The top of each attached page shows a question from the Force Concept Inventory. The "Pre" and "Post" columns show the percentage of students in the calculus-based course who selected each of the possible answers on the pretest (given at the beginning of the term) and the posttest (at the end of ten weeks of instruction).

1. Individually read all the questions.
2. For each question assigned to your group:
 - a. Describe briefly how a student might be thinking who selected each incorrect answer. (Hint: Review the alternative conceptions from the McDermott and Wandersee et. al., articles.)
 - b. Which of the possible "alternative conceptions" were successfully addressed by instruction? Which were not?
3. For one question assigned to your group, imagine you were tutoring a student with the indicated alternative conception. Discuss what example situation, reference to a common experience the student is likely to have, or set of questions that you think might help move this student away from their alternative conception. Write your answer on the back of this page.

Group Roles:

Skeptic: Ask what other possibilities there are, keep the group from superficial analysis by not allowing the group to agree too quickly; ask questions that lead to a deeper analysis; agree when satisfied that the group has explored all possibilities. (earliest birthday in year)

Manager: Suggest a plan for answering the questions; make sure everyone participates and stays on task; watch the time. (next later birthday in year)

Checker/Recorder: Ask others to explain their reasoning process so it is clear to all that their suggestions can be discussed; paraphrase, write down, and edit your group's answers to the questions. (next later birthday in year)

TIME: 25 minutes.

One member from each group will be randomly called on to contribute answers to the questions.

Group Product:

Activity #2 Answer Sheets.



Question 30

Despite a very strong wind, a tennis player manages to hit a tennis ball with her racquet so that the ball passes over the net and lands on her opponent's court.

Consider the following forces:

1. A downward force of gravity.
2. A force by the "hit".
3. A force exerted by the air.

Which following force(s) is (are) acting on the tennis ball after it has left contact with the racquet and before it touches the ground?

	<u>Pre</u>	<u>Post</u>
(A) 1 only	2	10
(B) 1 and 2	4	7
(C) 1 and 3	18	46
(D) 2 and 3	1	1
(E) 1, 2, and 3	75	36

1. Describe briefly how a student might be thinking who gives each incorrect answer.

2. Which of these "alternative conceptions" were successfully addressed by instruction? Which were not?

Question 19

20. Do the blocks ever have the same speed?

	<u>Pre</u>	<u>Post</u>
(A) No.	16	8
(B) Yes, at instant 2.	4	2
(C) Yes, at instant 5.	9	6
(D) Yes at instant 2 and 5.	20	20
(E) Yes at some time during interval 3 to 4.	51	65

1. Describe briefly how a student might be thinking who gives each incorrect answer.

2. Which of these “alternative conceptions” were successfully addressed by instruction? Which were not?



Question 13

A boy throws a steel ball straight up. Consider the motion of the ball only after it has left the boy's hand but before it touches the ground, and assume that forces exerted by the air are negligible. For these conditions, the force(s) acting on the ball is (are):

	<u>Pre</u>	<u>Post</u>
(A) a downward force of gravity along with a steadily decreasing upward force.	1	2
(B) a steadily decreasing upward force from the moment it leaves the boy's hand until it reaches its highest point; on the way down there is a steadily increasing downward force of gravity as the object gets closer to the earth.	17	3
(C) an almost constant downward force of gravity along with an upward force that steadily decreases until the ball reaches its highest point on the way down after there is only the constant downward force of gravity.	65	38
(D) an almost constant downward force of gravity only.	17	57
(E) none of the above -- the ball falls back to ground because of its natural tendency to rest on the surface of the earth.	0	1

1. Describe briefly how a student might be thinking who gives each incorrect answer.

2. Which of these "alternative conceptions" were successfully addressed by instruction? Which were not?

Question 11

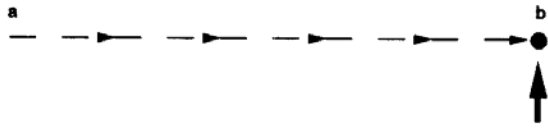

The main force(s) acting on the puck after the "kick" is (are):

	<u>Pre</u>	<u>Post</u>
(A) a downward force of gravity	9	3
(B) a downward force of gravity and a horizontal force in the direction of motion.	33	4
(C) a downward force of gravity, an upward force exerted by the surface, and a horizontal force in the direction of motion.	44	34
(D) the downward force of gravity and an upward force exerted by the surface.	13	59
(E) None. (No forces act on puck.)		

1. Describe briefly how a student might be thinking who gives each incorrect answer.

2. Which of these "alternative conceptions" were successfully addressed by instruction? Which were not?

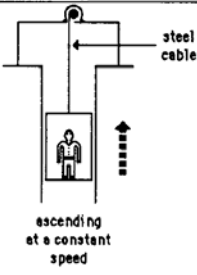

Question 17

An elevator is being lifted up an elevator shaft at a constant speed by a steel cable, as shown in the figure. All frictional effects are negligible. In this situation, forces on the elevator are such that:

	<u>Pre</u>	<u>Post</u>
(A) the upward force by the cable is greater than the downward force of gravity.	64	36
(B) the upward force by the cable is equal to the downward force of gravity.	18	60
(C) the upward force by the cable is smaller than the downward force of gravity.	2	0
(D) the upward force by the cable is greater than the sum of the downward force of gravity and a downward force due to the air.	11	2
(E) None of the above. (The elevator goes up because the cable is shortened, not because an upward force is exerted on the elevator by the cable).	5	1

1. Describe briefly how a student might be thinking who gives each incorrect answer.

2. Which of these “alternative conceptions” were successfully addressed by instruction? Which were not?



Question 4

A large truck collides head-on with a small compact car.

During the collision,

	<u>Pre</u>	<u>Post</u>
(A) the truck exerts a greater amount of force on the car than the car exerts on the truck	79	46
(B) the car exerts a greater amount of force on the truck than the truck exerts on the car.	2	1
(C) neither exerts a force on the other, the car gets smashed simply because it gets in the way of the truck.	0	0
(D) the truck exerts a force on the car, but the car doesn't exert a force on the truck.	0	0
(E) the truck exerts the same amount of force on the car as the car exerts on the truck.	19	53

1. Describe briefly how a student might be thinking who gives each incorrect answer.

2. Which of these “alternative conceptions” were successfully addressed by instruction? Which were not?



Question 15

While the car, still pushing the truck, is *speeding up* to get up to cruising speed;

	<u>Pre</u>	<u>Post</u>
(A) the amount of force of the car pushing against the truck is equal to that of the truck pushing back against the car.	19	25
(B) the amount of force of the car pushing against the truck is less than that of the truck pushing back against the car.	9	5
(C) the amount of force of the car pushing against the truck is greater than that of the truck pushing against the car.	68	69
(D) the car's engine is running so it applies a force as it pushes against the truck, but the truck's engine is not running so it can't push back against the car -- the truck is pushed forward simply because it is in the way of the car.	3	1
(E) neither the car nor the truck exert any force on the other, the truck is pushed forward simply because it is in the way of the car.	0	0

1. Describe briefly how a student might be thinking who gives each incorrect answer.

2. Which of these “alternative conceptions” were successfully addressed by instruction? Which were not?

3. Imagine you are tutoring a student who has an "alternative conception" similar to that of Question # _____. What example situation, reference to a common experience the student is likely to have, or set of questions do you think might help move this student away from their alternative conception?

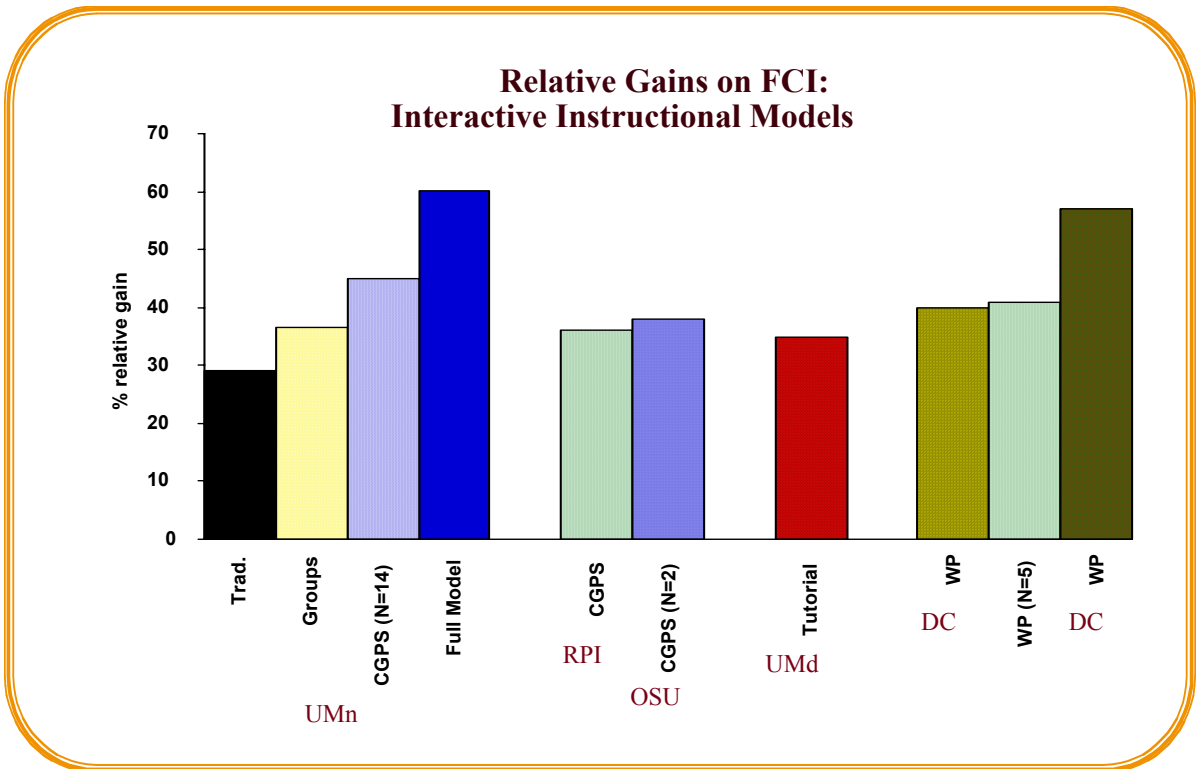
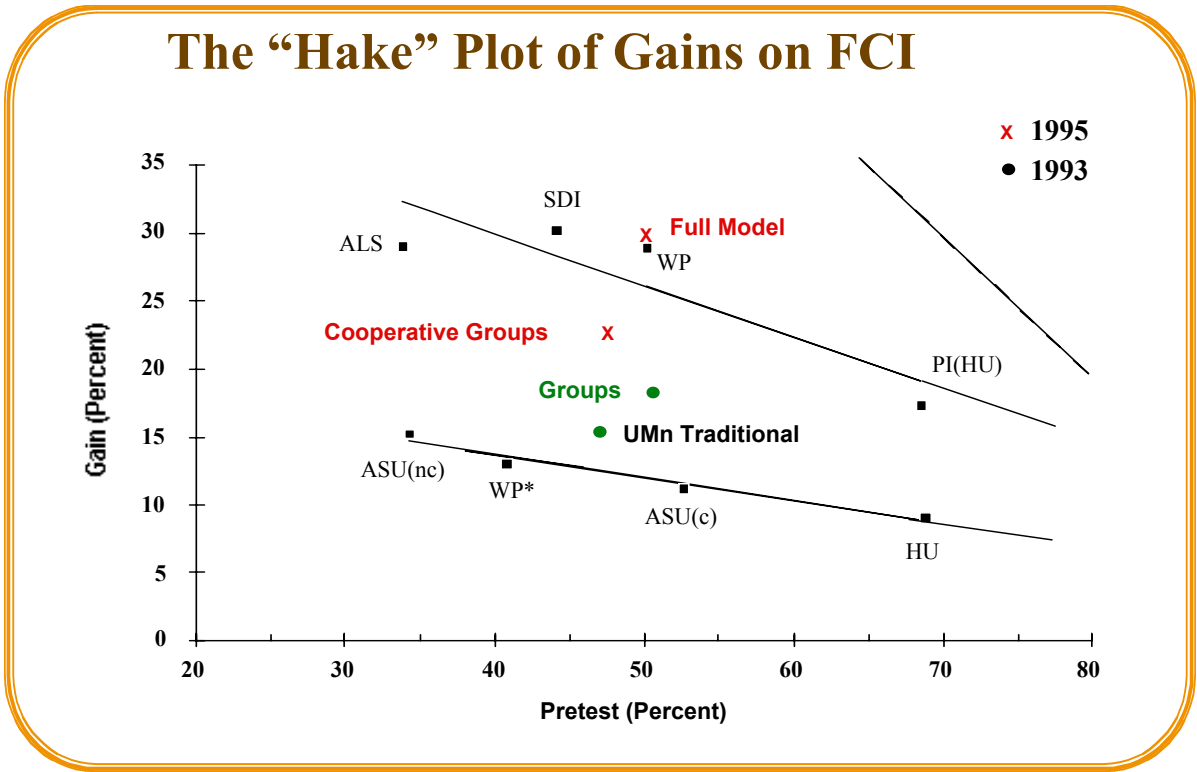

Instructors Notes for Alternative Conceptions in Dynamics
Part b: Open-ended Questions
(about 1 hour)

Activity #3: Analyzing Open-ended Questions

- a) Motivation: Tell TAs: "Many of you have commented on some of the problems with a multiple-choice test. So let's see how students respond to open-ended conceptual questions. These questions were given to the students in the calculus based course as a pretest (during the first week of class) and as a posttest (during the first week of the second quarter). The responses you will be analyzing all come from the posttest. All responses are from students who passed the first-quarter course with an A, B or C grade.

The responses to these questions gives you more information about how students are thinking than you get from the FCI or from grading the problem-solving tests. That is, what the students write is more like what they sound like when they work in groups in the lab or discussion sessions. So this activity is good practice for beginning to develop your diagnosis skills. As a TA, you will have to listen to what students say, try to figure out what your student's conceptual difficulty could be, then think of a way to try to help them."

- b) Activity #3: Explain task briefly (see page 55). Assign the following students to each group:

Group	Student #	Group	Student #
1	5	6	10
2	6	7	12
3	7	8	13
4	8	9	14
5	9	10	15

Have students **rotate roles**, and remind them to work on the group functioning goal they set at the end of Activity #2.

- c) Closure: Call on students for answers to each question, and discuss.

It is helpful to show and discuss overheads of summary posttest results (see pages 73 - 74).

Description of data: Baseline data for the calculus-based course data was collected by randomly selecting about 33 students from each of three different sections of the course (1993). The 1996 data was collected at the beginning of spring quarter in one section of the calculus based course. 71 students had the same instructor using the full model (explicit

teaching of a problem-solving strategy plus cooperative group problem solving) for two quarters. 85 students had transferred into the course from other sections that used group problem solving in discussion sections, but no explicit problem-solving strategy was taught.

These results support the findings of McDermott's Physics Education group at the University of Washington: "The use of the word 'force' and other technical terms is ambiguous and unstable. . . the underlying conceptual problems were complex and could not be adequately summarized as a simple belief in the necessity of a force in the direction of motion."

Manager: _____
Recorder: _____
Skeptic: _____
Skeptic: _____

Alternative Conceptions in Dynamics: Analyzing Open-Ended Questions

Group Task:

The attached sheets contain student responses to two open-ended questions given to students in the calculus-based course as a **posttest** (after ten weeks of instruction).

1. First read through the responses of Students #1, #2 and #3. These students wrote fairly good and complete answers to the questions.
2. Now read through the remainder of the student answers and discuss them with your group.
 - What is one thing that surprised you about these responses? Why?
 - What is one thing that did not surprise you? Why?
3. Read through the responses again, and answer the first three questions on the next page.
4. Imagine you were tutoring the student assigned to your group. What example situation, reference to a common experience students are likely to have, or set of questions do you think might help move the student away from their alternative conception(s)? Discuss.

Group Roles:

Skeptic: Ask what other possibilities there are, keep the group from superficial analysis by not allowing the group to agree too quickly; ask questions that lead to a deeper analysis; agree when satisfied that the group has explored all possibilities.

Manager: Suggest a plan for answering the questions; make sure everyone participates and stays on task; watch the time.

Checker/Recorder: Ask others to explain their reasoning process so it is clear to all that their suggestions can be discussed; paraphrase, write down, and edit your group's answers to the questions.

TIME: 25 minutes.

One member from each group will be randomly called on to contribute answers to the questions.

Group Product:

Answer Sheet for Activity #3.

Answer Sheet

1. What conceptual difficulties do Students #4, #5 and #6 have with the concept of acceleration? (Hint: You may want to look at the McDermott article, page 27).
2. Which students' responses to the passenger/car questions indicate a **forward** force on the passenger or car which is a "pseudo-force" or non-Newtonian force (i.e., not caused by the interaction of the passenger or car with real objects). What might these students be thinking to indicate these non-Newtonian forces? What is your evidence?
3. Which students' responses to the passenger/car questions indicate a **backward** force on the passenger or car which is a "pseudo-force" or non-Newtonian force (i.e., not caused by the interaction of the passenger or car with real objects). What might these students be thinking to indicate these non-Newtonian forces? What is your evidence?
10. What example situation, reference to a common experience students are likely to have, or set of questions do you think might help move Student # ____ away from their alternative conception(s)?

The following questions are for course evaluation purposes only and will not be graded. They will help us evaluate how well we met your learning needs this course.

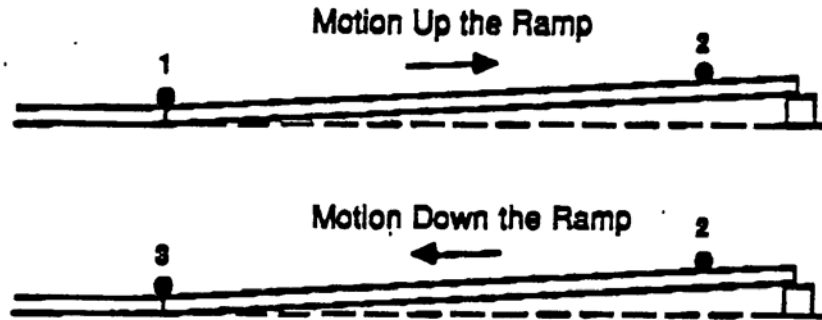

1. A steel ball is launched with some initial velocity, slows down as it travels up a gentle incline, reverses direction, and then speeds up as it returns to its starting point. Assume friction is negligible.
 - (a) Suppose we calculated the acceleration of the ball as it's moving up the ramp (from 1 to 2), and the acceleration as it's moving down the ramp (from 2 to 3). How would these two accelerations compare? (i.e., Are the accelerations the same size? The same direction?) Explain your reasoning.

The acceleration of the ball as it moves up the ramp would be an acceleration of the same direction as it moved down the ramp. They would also be of the same size, because the slope of the ramp is constant throughout the event.

- (b) Does the ball have an acceleration at its highest point on the incline (at position 2)? Explain your reasoning.

Yes, at its highest point the acceleration is still the same as before, the velocity however is 0.

Student #1

3. You are a passenger in a car which is traveling on a straight road while it is increasing speed from 30 mph to 55 mph. You wonder what forces cause you and the car to accelerate. When you pull over to eat, you decide to figure it out.

(a) On the left side of the table below, draw and label arrows representing all the forces acting on you (passenger) while the car is accelerating. The length of the arrows should indicate the relative sizes of the forces (i.e., a larger force should be represented by a clearly longer arrow, equal forces by arrows of equal length). On the right side of the table, describe each force in words (i.e., What kind of force is it? Is the force a push or a pull? What object, if any, is exerting the force? What object is being affected by the force?).

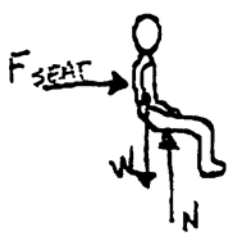
You (Passenger)	Description of Each Force
	<p>F_{SEAT} = FORCE OF THE SEAT PUSHING YOU AS THE CAR ACCELERATES. PUSH</p> <p>W = GRAVITATIONAL FORCE OF EARTH ON YOU. PULL</p> <p>N = NORMAL FORCE OF SEAT PUSHING ON YOU.</p>

(b) Which force(s) cause you (passenger) to accelerate? Explain your reasoning.

F_{SEAT} CAUSES YOU TO ACCELERATE BECAUSE IT IS NOT COUNTERACTED BY ANY OTHER FORCES.

Student #2

- (c) On the left side of the table below, draw and label arrows representing all the forces acting on the car while it is accelerating. The length of the arrows should indicate the relative sizes of the forces (i.e., a larger force should be represented by a clearly longer arrow, equal forces by arrows of equal length). On the right side of the table, describe each force in words (i.e., What kind of force is it? Is the force a push or a pull? What object, if any, is exerting the force? What object is being affected by the force?).

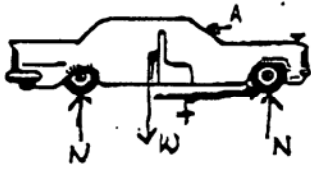
Car	Description of Each Force
<p style="text-align: right;">front wheel drive car.</p> 	<p>W = the gravitational pull of the earth on the car</p> <p>N = the support force of the road on the car, distributed evenly on all four tires.</p> <p>A = the ^{drag} force of the air on the car as it moves forward.</p> <p>f = the frictional force of the road on the tires causing forward motion.</p>

- (d) Which force(s) cause the car to accelerate? Explain your reasoning.

The frictional force of the road on the tires causes the car to accelerate. The tires are moving \circlearrowright in that direction and if there were no friction, they would just spin. Since there is friction between the road and tires it acts in \rightarrow this direction causing the car to move forward. This is static friction.

Student #3

The following questions are for course evaluation purposes only and will not be graded. They will help us evaluate how well we met your learning needs this course.

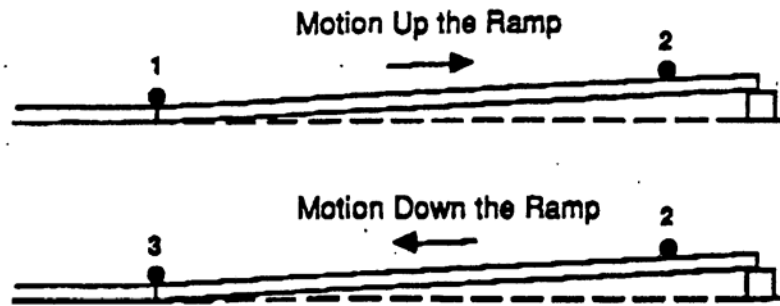

1. A steel ball is launched with some initial velocity, slows down as it travels up a gentle incline, reverses direction, and then speeds up as it returns to its starting point. Assume friction is negligible.

- (a) Suppose we calculated the acceleration of the ball as it's moving *up* the ramp (from 1 to 2), and the acceleration as it's moving *down* the ramp (from 2 to 3). How would these two accelerations compare? (i.e., Are the accelerations the same size? The same direction?) Explain your reasoning.

The acceleration of the ball from 2 to 3 would be larger than the acceleration of the ball from 1 to 2 because it takes more work for the ball to go up the ramp than to go down the ramp. The accelerations would be in the same direction.

- (b) Does the ball have an acceleration at it's highest point on the incline (at position 2)? Explain your reasoning.

No, it does not, it must stop, at least for a second, so it can reverse its direction.

Student #4

The following questions are for course evaluation purposes only and will not be graded. They will help us evaluate how well we met your learning needs this course.

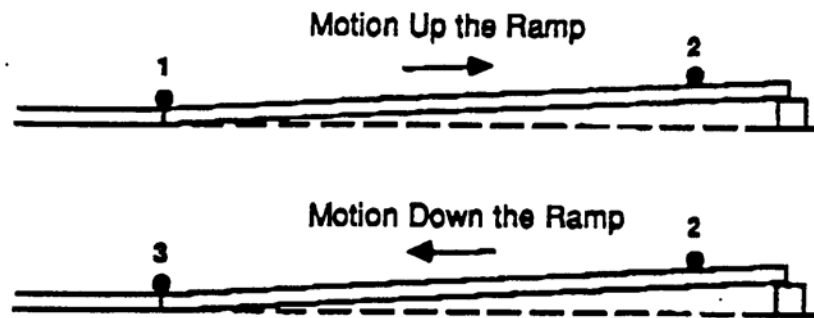

1. A steel ball is launched with some initial velocity, slows down as it travels up a gentle incline, reverses direction, and then speeds up as it returns to its starting point. Assume friction is negligible.
 - (a) Suppose we calculated the acceleration of the ball as it's moving *up* the ramp (from 1 to 2), and the acceleration as it's moving *down* the ramp (from 2 to 3). How would these two accelerations compare? (i.e., Are the accelerations the same size? The same direction?) Explain your reasoning.

The accelerations are in opposite directions. One is positive by going down the ramp and gaining speed, but the other is negative by going up the ramp and then slowing down.

- (b) Does the ball have an acceleration at it's highest point on the incline (at position 2)? Explain your reasoning.

At the point the ball turns around, there will be no acceleration since at this point $v=0$. The acceleration will start once again as the ball starts moving down the incline.

Student # 5

The following questions are for course evaluation purposes only and will not be graded. They will help us evaluate how well we met your learning needs this course.

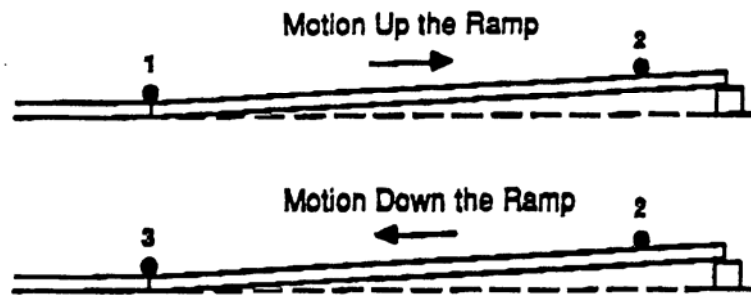

1. A steel ball is launched with some initial velocity, slows down as it travels up a gentle incline, reverses direction, and then speeds up as it returns to its starting point. Assume friction is negligible.
 - (a) Suppose we calculated the acceleration of the ball as it's moving up the ramp (from 1 to 2), and the acceleration as it's moving down the ramp (from 2 to 3). How would these two accelerations compare? (i.e., Are the accelerations the same size? The same direction?) Explain your reasoning.

To compare the two accelerations we would find the magnitudes to be approximately the same, to give the acceleration direction you must consider which way the motion is in relation to acceleration. So from one to two there is a negative acceleration because the acceleration is in the opposite direction of motion. From two to three acceleration is positive because it is the same direction as the motion.

- (b) Does the ball have an acceleration at it's highest point on the incline (at position 2)? Explain your reasoning.

The magnitude of the ball at point 2 is zero. With the ball at this point, the direction of motion is changing so acceleration doesn't exist at that instantaneous position.

Student # 6

3. You are a passenger in a car which is traveling on a straight road while it is increasing speed from 30 mph to 55 mph. You wonder what forces cause you and the car to accelerate. When you pull over to eat, you decide to figure it out.

(a) On the left side of the table below, draw and label arrows representing all the forces acting on you (passenger) while the car is accelerating. The length of the arrows should indicate the relative sizes of the forces (i.e., a larger force should be represented by a clearly longer arrow, equal forces by arrows of equal length). On the right side of the table, describe each force in words (i.e., What kind of force is it? Is the force a push or a pull? What object, if any, is exerting the force? What object is being affected by the force?).

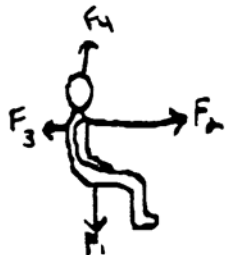
You (Passenger)	Description of Each Force
	<p>F_1 = force of gravity by earth (Pull)</p> <p>F_2 = force from acceleration of car (Pull)</p> <p>F_3 = force of inertia pulling back</p> <p>F_4 = Normal force from seat (Push)</p>

(b) Which force(s) cause you (passenger) to accelerate? Explain your reasoning.

The force from the car causes you to accelerate, because it is larger than the inertial force

Student # 7

3. You are a passenger in a car which is traveling on a straight road while it is increasing speed from 30 mph to 55 mph. You wonder what forces cause you and the car to accelerate. When you pull over to eat, you decide to figure it out.
- (a) On the left side of the table below, draw and label arrows representing all the forces acting on you (passenger) while the car is accelerating. The length of the arrows should indicate the relative sizes of the forces (i.e., a larger force should be represented by a clearly longer arrow, equal forces by arrows of equal length). On the right side of the table, describe each force in words (i.e., What kind of force is it? Is the force a push or a pull? What object, if any, is exerting the force? What object is being affected by the force?).

You (Passenger)	Description of Each Force
	<p>The push force from the back of the car seat is equal to the push force from your back while the car accelerates.</p> <p>The force of gravity is equal to the normal force of the seat bottom pushing up on you.</p>

- (b) Which force(s) cause you (passenger) to accelerate? Explain your reasoning.

The force of the car seat pushing you along with the car.

Student # 8

3. You are a passenger in a car which is traveling on a straight road while it is increasing speed from 30 mph to 55 mph. You wonder what forces cause you and the car to accelerate. When you pull over to eat, you decide to figure it out.
- (a) On the left side of the table below, draw and label arrows representing all the forces acting on you (passenger) while the car is accelerating. The length of the arrows should indicate the relative sizes of the forces (i.e., a larger force should be represented by a clearly longer arrow, equal forces by arrows of equal length). On the right side of the table, describe each force in words (i.e., What kind of force is it? Is the force a push or a pull? What object, if any, is exerting the force? What object is being affected by the force?).

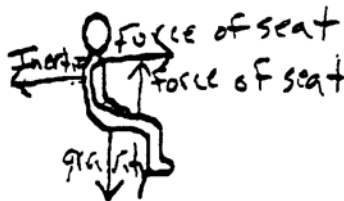
You (Passenger)	Description of Each Force
	<p><u>Inertia</u> - the car is accelerating forward, but your body wants to stay in its original position, and you are pushed into the seat.</p> <p><u>gravity</u> - gravity pushes you into the seat and holds you in the car</p> <p><u>Force of seat</u> - seat pushing back on you as you try to resist motion</p>

- (b) Which force(s) cause you (passenger) to accelerate? Explain your reasoning.

The force of the seat propels you forward
~~The~~ The force of the accelerating car is transferred to the seat, which is part of the car.

Student # 9

3. You are a passenger in a car which is traveling on a straight road while it is increasing speed from 30 mph to 55 mph. You wonder what forces cause you and the car to accelerate. When you pull over to eat, you decide to figure it out.

(a) On the left side of the table below, draw and label arrows representing all the forces acting on you (passenger) while the car is accelerating. The length of the arrows should indicate the relative sizes of the forces (i.e., a larger force should be represented by a clearly longer arrow, equal forces by arrows of equal length). On the right side of the table, describe each force in words (i.e., What kind of force is it? Is the force a push or a pull? What object, if any, is exerting the force? What object is being affected by the force?).

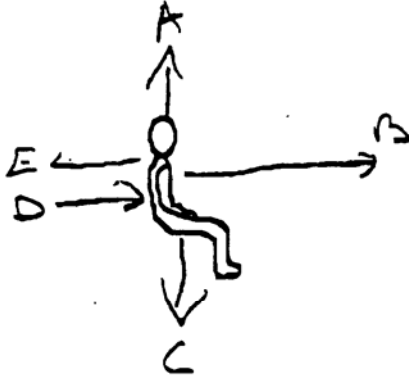
You (Passenger)	Description of Each Force
	<p>A: force at earth to seat</p> <p>B: Force of the engine</p> <p>C: Force of gravity</p> <p>D: Force at seat</p> <p>E: Force you exert on seat</p>

(b) Which force(s) cause you (passenger) to accelerate? Explain your reasoning.

E, D, A, C they keep you in the seat

Student #10

3. You are a passenger in a car which is traveling on a straight road while it is increasing speed from 30 mph to 55 mph. You wonder what forces cause you and the car to accelerate. When you pull over to eat, you decide to figure it out.
- (a) On the left side of the table below, draw and label arrows representing all the forces acting on you (passenger) while the car is accelerating. The length of the arrows should indicate the relative sizes of the forces (i.e., a larger force should be represented by a clearly longer arrow, equal forces by arrows of equal length). On the right side of the table, describe each force in words (i.e., What kind of force is it? Is the force a push or a pull? What object, if any, is exerting the force? What object is being affected by the force?).

You (Passenger)	Description of Each Force
	<p>F_g = force of gravity</p> <p>F_N = Normal force</p> <p>F_R = Force of resistance (inertia)</p> <p>F_F = Force Forward from engine</p>

- (b) Which force(s) cause you (passenger) to accelerate? Explain your reasoning.

F_F \Rightarrow the engine.
force of the, transmitted via the car.

Student #11

- (c) On the left side of the table below, draw and label arrows representing all the forces acting on the *car* while it is accelerating. The length of the arrows should indicate the relative sizes of the forces (i.e., a larger force should be represented by a clearly longer arrow, equal forces by arrows of equal length). On the right side of the table, describe each force in words (i.e., What kind of force is it? Is the force a push or a pull? What object, if any, is exerting the force? What object is being affected by the force?).

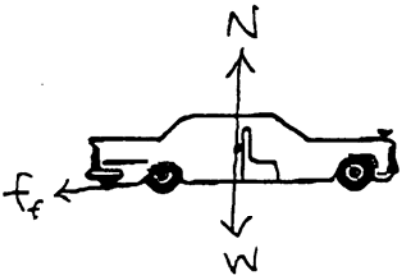
Car	Description of Each Force
	<p>N = normal force</p> <p>f_f = frictional force between road ^{road} + tire.</p> <p>W = gravitational pull of earth on the car.</p>

- (d) Which force(s) cause the car to accelerate? Explain your reasoning.

The frictional force and gravitational pull cause the car to accelerate. The frictional force between the tires and the road allow the car to move forward and accelerate.

Student # 12

- (c) On the left side of the table below, draw and label arrows representing all the forces acting on the car while it is accelerating. The length of the arrows should indicate the relative sizes of the forces (i.e., a larger force should be represented by a clearly longer arrow, equal forces by arrows of equal length). On the right side of the table, describe each force in words (i.e., What kind of force is it? Is the force a push or a pull? What object, if any, is exerting the force? What object is being affected by the force?).

Car	Description of Each Force
	<p>F_f - the force of friction the car + the road exert.</p> <p>F - the force caused by the cars mass and acceleration.</p>

- (d) Which force(s) cause the car to accelerate? Explain your reasoning.

The force of motion causes the car to accelerate
 Because of the force of motion + the mass of the car, it accelerates.

Student # 13

- (c) On the left side of the table below, draw and label arrows representing all the forces acting on the car while it is accelerating. The length of the arrows should indicate the relative sizes of the forces (i.e., a larger force should be represented by a clearly longer arrow, equal forces by arrows of equal length). On the right side of the table, describe each force in words (i.e., What kind of force is it? Is the force a push or a pull? What object, if any, is exerting the force? What object is being affected by the force?).

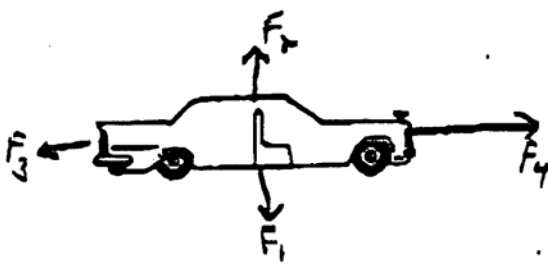
Car	Description of Each Force
	<p>F_1 = force of gravity from earth (pull)</p> <p>F_2 = Normal force from road (push)</p> <p>F_3 = force of friction from road & tires (pull)</p> <p>F_4 = accelerating force from car's motor (pull)</p>

- (d) Which force(s) cause the car to accelerate? Explain your reasoning.

The force from the motor because it exceeds the force of friction.

Student # 14

- (c) On the left side of the table below, draw and label arrows representing all the forces acting on the car while it is accelerating. The length of the arrows should indicate the relative sizes of the forces (i.e., a larger force should be represented by a clearly longer arrow, equal forces by arrows of equal length). On the right side of the table, describe each force in words (i.e., What kind of force is it? Is the force a push or a pull? What object, if any, is exerting the force? What object is being affected by the force?).

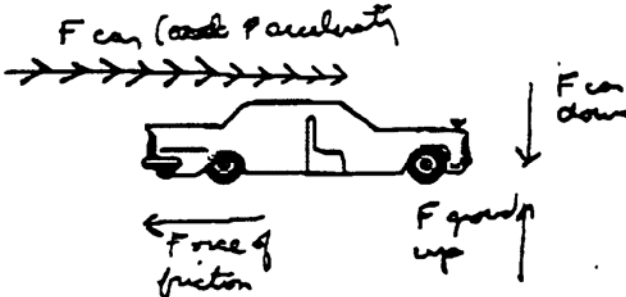
Car	Description of Each Force
	<p>The force of car increase as the car accelerates.</p> <p>$F_{\text{car down}} = F_{\text{ground up}}$</p> <p>Force of friction = $F_{\text{ground up}}$ but act against F_{car} accelerating.</p>

- (d) Which force(s) cause the car to accelerate? Explain your reasoning.

Force of friction + $F_{\text{car down}}$ + $F_{\text{ground up}}$ (normal force) all helps the car to accelerate because they F of friction acts in the opposite direction which gives the car an amount of acceleration.

Student # 15

(c) On the left side of the table below, draw and label arrows representing all the forces acting on the car while it is accelerating. The length of the arrows should indicate the relative sizes of the forces (i.e., a larger force should be represented by a clearly longer arrow, equal forces by arrows of equal length). On the right side of the table, describe each force in words (i.e., What kind of force is it? Is the force a push or a pull? What object, if any, is exerting the force? What object is being affected by the force?).

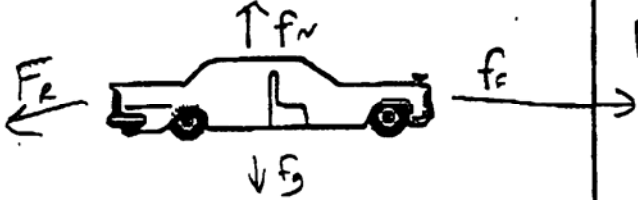
Car	Description of Each Force
	<p>$F_N \Rightarrow$ normal, opposite to F_g</p> <p>$F_g \Rightarrow$ force of gravity</p> <p>$F_f \Rightarrow$ force forward from engine</p> <p>$F_R \Rightarrow$ force of resistance (air, friction)</p>

(d) Which force(s) cause the car to accelerate? Explain your reasoning.

F_f , force forward no other choice.

Student #16

 <i>What is the Nature of the Forces on the Passenger?</i>	FCI post 68% 1993		FCI 72% 1996	FCI 82% 1996
	Baseline (n = 100)		Coop Group (n=85)	Full Model (n=71)
	pre (%)	post (%)	post (%)	post (%)
Type of Response				
1. Only Newtonian forces	12	41	59	76
2. Newtonian forces, but some are 3rd Law pair on wrong object	24	24	8	4
3. Include non-Newtonian forces (e.g., acceleration of car, engine, inertia, etc.)	62	35	32	20
4. Uncodeable	8	1	0	0

 <i>What is the Nature of the Forces on the Car?</i>	FCI post 68% 1993		FCI 72% 1996	FCI 82% 1996
	Baseline (n = 100)		Coop Group (n=85)	Full Model (n=71)
	pre (%)	post (%)	post (%)	post (%)
Type of Response				
1. Only Newtonian forces	10	39	58	73
2. Newtonian forces, but some are 3rd Law pair on wrong object	4	15	4	2
3. Include non-Newtonian forces (e.g., acceleration of car, engine, inertia, etc.)	73	39	38	25
4. Uncodeable	8	1	0	0

 Why Does the Passenger Accelerate?	FCI post 68% 1993		FCI 72% 1996	FCI 82% 1996
	Baseline (n = 100)		Coop Group (n=85)	Full Model (n=71)
	pre (%)	post (%)	post (%)	post (%)
1. Includes correct ideas about summing real forces	9	33	28	42
2. Vague or incorrect summing	13	11	13	13
3. Includes alternative ideas				
a. accel. due to one force	14	17	23	7
b. accel. not due to real force on the passenger	57	35	24	34
4. Uncodeable	7	5	12	4

 Why Does the Car Accelerate?	FCI post 68% 1993		FCI 72% 1996	FCI 82% 1996
	Baseline (n = 100)		Coop Group (n=85)	Full Model (n=71)
	pre (%)	post (%)	post (%)	post (%)
1. Includes correct ideas about summing real forces	7	20	42	58
2. Vague or incorrect summing	25	29	24	21
3. Includes alternative ideas				
a. accel. due to one force	4	23	21	19
b. accel. not due to real force on the car	48	23	7	0
4. Uncodeable	16	7	6	4

Teaching Problem-solving Discussion Sections

Related Readings -- Articles

- Heller, P., Keith, R., and Anderson, S. (1992). Teaching problem solving through cooperative grouping. Part 1: Group versus individual problem solving. *American Journal of Physics*, **60**, 627-636.
- Heller, P., Hollabaugh, M. (1992). Teaching problem solving through cooperative grouping. Part 2: Designing problems and structuring groups. *American Journal of Physics*, **60**, 637-644.
- Larkin, J. H. (1979). Processing information for effective problem solving. *Engineering Education* (December), 285-288.

Related Readings -- Instructor's Discussion Session Manual

The following readings from the Instructor's Handbook are included in this booklet:

- FAQ About Cooperative-group Problem Solving (pages 167 - 169)
- Outline for Teaching a Discussion Session (page 170)
- Detailed Advice for Teaching the Discussion Sessions (pages 171 - 174)

Activities

1. Structure and Rationale of Discussion Sessions (pages 157 - 158)
 - Activities #4: How are Discussion Sessions Taught at the U of Mn? (pages 159 - 166)
2. Student Difficulties With Problem Solving (pages 175 - 177)
 - Activity #6: Differences in Expert and Novice Problem-solving (pages 179 - 186)
 - Activity #7: Methods Questions and Problem Solving (pages 187 - 197)
 - Activity #8: Practice Using a Strategy (pages 199 - 202)
 - Homework #4: Using a Strategy to Solve a Context-rich Problem (pages 203 - 206)
3. Characteristics of Good Group Problems (pages 207 - 210)
 - Activity #11: Designing a Group Problem (pages 211 - 225)
 - Homework #6: Judging Group Problems (pages 227 - 230)

Instructor's Notes for Structure and Rationale of Discussion Sections (about 1.5 hours)

The purpose of this activity is to introduce students to their role as instructors in the discussion sections and provide a rationale for the structure of the discussion sections.

Activity #4: How are Discussion Sessions Taught at the U of Mn? (about 1.5 hours)

The TAs first read the Heller, Keith and Anderson (1992) article and the Larkin (1979) and Martinez (1998) articles about problem solving (see Reading Packet).

Demonstration of a Discussion Session (about 1 hour)

Again, we have an experienced TA model how to conduct a typical discussion session, including group processing (see also Activity #9, and the general lesson plan for a discussion session on pages 170-174). To make the experience more analogous to what students experience in introductory courses, we have the TAs solve a problem from an old Graduate Written Exam. The TAs usually enjoy this activity — they get very involved with solving this "real" problem (much like the students in the introductory course) and they don't want to stop.

Activity #5: Rationale for Lab and Discussion Section Structure (about 30 minutes)

It is important to discuss with the TAs the goals of the introductory course(s) and the role of labs and discussion/recitation sections in helping students to meet these goals. At the University of Minnesota, we have gathered data which supports our goals, and both our discussion sessions and labs are specifically coordinated and designed to help students meet these goals.

1. *Goals and Topics*: Discuss the design of our survey of Engineering Departments, and the results for goals and topics — why we emphasize using fundamental concepts and principles to solve problems (see pages 159-162).
2. *Why Cooperative-group Problem Solving*: Discuss "The Dilemma" (see pages 163-164) — give a brief history of how we came to use cooperative group problem solving.
3. *Structure of Discussion/Labs*: Discuss survey results for desired structure for discussion and lab sessions (see pages 165-166). Have TAs examine the Table of Lab Comparisons (see page 166). Explain that our labs are designed to support the major goal of the introductory courses — to help students use fundamental concepts and principles to solve problems. So the instructions for our labs are somewhere between traditional verification labs and inquiry labs — enough guidance so *groups* can figure out what to do with minimal help from the instructors, but NOT "cookbook" labs.

4. Answer any questions TAs have about lab or discussion session structure.

After this session, the TAs read three handouts in their "Instructor's Handbook." These handouts are included on pages 167-174. The *FAQ About Discussion Sections* is essentially an outline of the Heller and Hollabaugh (1992) article. The *Outline for Teaching a Discussion Section* and *Detailed Advice for Teaching the Discussion Sections* outline and describe in detail the major instructor actions during a cooperative group discussion section. These handouts are purposely much like the handouts for teaching the lab in order to emphasize the similarities of the two situations. The only difference is that students solve word problems during discussion section, and experimental problems during the lab.

Frequently Asked Questions (FAQ) About Cooperative-Group Problem-Solving

For a more extended discussion of the following questions, see Heller and Hollabaugh (1992) in reading packet.

What size groups should I form?

For discussion and laboratory sections, form groups of **three**. Previous research indicates that groups of three work better than pairs or groups of four. With pairs, there is often not enough physics knowledge to solve the problem. In groups of four, one member tends to be left out of the process.

When your class size is not divisible by three, however, you will end up with a few pairs or a group of four. For discussion sections form groups of four. For the laboratory, break the group of four into two pairs.

How do I assign students to groups?

Previous research indicates that mixed-ability groups (based on past performance on problem-solving tests) work better than homogeneous-ability groups. In addition, groups of two men and one woman do not work well, particularly at the beginning of the course. (The men tend to ignore the woman, even if she is the highest ability student in the group.) Until you get to know your students, try groups of three men, three women, or two women and one man. Use the following procedure:

1. Write each student's total test scores, gender, and major on either index cards or a computer spreadsheet, as illustrated below.
2. Compute a cumulative total score for each student.

Name	Test 1	Test 2	Total	Perf.	Gender	Major	Group
Anderson, Max	62	71	133		Male	Arch	
Black, Jennifer	93	85	178		Female	Ecol	
Brown, John	78	79	157		Male	Phar	
Edwards, Mark	54	58	112		Male	Dent	
Fairweather, Joan	73	65	138		Female	Vet	
Freedman, Joshua	55	49	104		Male	Arch	
Good, Mary	100	95	195		Female	Phy Th	
Green, Bill	79	83	162		Male	Arch	
Johnson, Fred	69	70	139		Male	Arch	
Jones, Rachel	59	63	122		Female	Wildlife	
Peterson, Scott	69	61	130		Male	Arch	
Smith, Patricia	70	77	147		Female	Arch	

South, David	48	50	98		Male	Phar	
West, Tom	52	55	107		Male	Vet	
White, Sandra	86	92	178		Female	Math	

3. Sort your class by total cumulative score (highest to lowest). Divide the class into thirds (high performance, medium performance and low performance students). Identify the performance level of each student.

Name	Test 1	Test 2	Total	Perf.	Gender	Major	Group
Good, Mary	100	95	195	High	Female	Phy Th	1
Black, Jennifer	93	85	178	High	Female	Ecol	2
White, Sandra	86	92	178	High	Female	Math	3
Green, Bill	79	83	162	High	Male	Arch	4
Brown, John	78	79	157	High	Male	Phar	5
Smith, Patricia	70	77	147	Medium	Female	Arch	2
Johnson, Fred	69	70	139	Medium	Male	Arch	3
Fairweather, Joan	73	65	138	Medium	Female	Vet	1
Anderson, Max	62	71	133	Medium	Male	Arch	4
Peterson, Scott	69	61	130	Medium	Male	Arch	5
Jones, Rachel	59	63	122	Low	Female	Wildlife	3
Edwards, Mark	54	58	112	Low	Male	Dent	2
West, Tom	52	55	107	Low	Male	Vet	5
Freedman, Joshua	55	49	104	Low	Male	Arch	1
South, David	48	50	98	Low	Male	Phar	4

4. Assign three students to a group -- one high performance, one medium performance, and one low performance. If the class size is not divisible by three, assign one or two groups with four members (or pairs for computer labs).

Assign by gender -- two women and one man, three women, or three men. Never have a group with more men than women. Never end up with *all* single-gender groups (e.g., 4 groups of men and 1 group of women).

If possible, mix the groups by major (e.g., try not to have three architecture majors or electrical engineering majors in the same group).

Note: If you do this procedure on a spreadsheet, you can assign each student a group number, sort by group number, and get a printout of your groups.

Name	Test 1	Test 2	Total	Perf.	Gender	Major	Group
Good, Mary	100	95	195	High	Female	Phy Th	1
Fairweather, Joan	73	65	138	Medium	Female	Vet	1
Freedman, Joshua	55	49	104	Low	Male	Arch	1
Black, Jennifer	93	85	178	High	Female	Ecol	2
Smith, Patricia	70	77	147	Medium	Female	Arch	2
Edwards, Mark	54	58	112	Low	Male	Dent	2
White, Sandra	86	92	178	High	Female	Math	3
Jones, Rachel	59	63	122	Low	Female	Wildlife	3
Johnson, Fred	69	70	139	Medium	Male	Arch	3
Green, Bill	79	83	162	High	Male	Arch	4
Anderson, Max	62	71	133	Medium	Male	Arch	4
South, David	48	50	98	Low	Male	Phar	4
Brown, John	78	79	157	High	Male	Phar	5
Peterson, Scott	69	61	130	Medium	Male	Arch	5
West, Tom	52	55	107	Low	Male	Vet	5

How often should I change the groups?

Formal cooperative groups need to stay together long enough to be successful. On the other hand, they should be changed often enough so students realize they can make *any* group successful -- that their success is not due to being in a "magic" group.

In the first semester, change groups after each test (3 to 4 times). In the second semester, you can change only 2 - 3 times.

In the beginning of the course, it is important to give students a rationale for assigning them to groups and changing groups often. We tell our students that:

- (a) "We want you to get to know everyone in the class, so we will change groups often. By the end of the term, you will have worked with almost everyone in this class (section)."
- (b) "No matter what career you enter, you will have to work cooperatively with many different kinds of people (not just your friends). So you should begin to learn how to work comfortably and successfully in groups."

How can problems of dominance by one student and conflict avoidance within a group be addressed?

and

How can individual accountability (hitch-hiking) be addressed/

Below are six suggestions to help you maintain good group functioning.

1. Seating Arrangement: In discussion section, make sure the seats are arranged so students are facing each other, "knee-to-knee." This makes it much harder for a student to remain uninvolved with a group. If you observe students sitting in a row, or one student sitting "outside" a pair, go over to the group and make them stand up and rearrange their chairs.

In labs, make sure students are standing or sitting so they are all facing each other. In computer labs, make sure all students can see the screen. If you observe a group with one member doing all the work or one member left out, go over to the group and make them rearrange their seating/standing.

2. One Group Product in Discussion Section: To promote interdependence (and reduce dominance by one student), specify that only **one** problem solution can be turned in by each group and all members must sign the solution.

Do **NOT** let students use their textbooks while solving the problem. (The only book students should be allowed to use is *The Competent Problem Solver*.) Students should be co-constructing a solution, using each other as resources. The mathematical relationships, fundamental principles, and specific concepts needed to solve the problem should be either listed on the same sheet as the problem statement or on the blackboard. (Note: This list should increase as the semester progresses -- do not give students only the relationships they need to solve the problem. See Homework #7 for examples.)

Do **NOT** let each student in a group first solve the problem individually, then discuss their solutions. **THIS IS NOT COOPERATIVE-GROUP PROBLEM SOLVING.** If students persist in this behavior after a reminder, you may need to take the pencils away from the Manager and Skeptic (see below). Only the Recorder/Checker should be writing.

3. Roles: Assign each student a specific role (Manager, Recorder/Checker, and Skeptic/Summarizer). These roles were selected to correspond to the planning and monitoring strategies individuals must perform *independently* when solving problems -- the manager who designs plans of action; the skeptic, who questions

premises and plans; the recorder, who organizes and writes what has been done so far. In addition, each person has a responsibility to make sure the group functions effectively. The Manager must ensure that everyone in the group participates and contributes. The Checker/Recorder must ensure that all group members can explicitly explain how the problem was solved. The Skeptic/Summarizer keeps track of decisions and reasons for different actions, and summarizes them for the group.

The first time students work together, each member is *assigned* one of these roles. Each subsequent time the same group works together, their roles **MUST ROTATE**. This is particularly important for the computer labs. One way to accomplish this is to list the group members with roles (M, R, S) on the board. You can use a spreadsheet to keep track of the roles you have assigned to each group member, as illustrated below.

Name	Group	DS 10/15	Lab 10/20	DS 10/22	Lab 10/27	DS 10/29	Lab 11/3
Good, Mary	1	M	S	R	M	S	R
Fairweather, Joan	1	R	M	S	R	M	S
Freedman, Joshua	1	S	R	M	S	R	M
Black, Jennifer	2	M	S	R	M	S	R
Smith, Patricia	2	R	M	S	R	M	S
Edwards, Mark	2	S	R	M	S	R	M
White, Sandra	3	M	S	R	M	S	R
Jones, Rachel	3	R	M	S	R	M	S
Johnson, Fred	3	S	R	M	S	R	M
Green, Bill	4	M	S	R	M	S	R
Anderson, Max	4	R	M	S	R	M	S
South, David	4	S	R	M	S	R	M
Brown, John	5	M	S	R	M	S	R
Peterson, Scott	5	R	M	S	R	M	S
West, Tom	5	S	R	M	S	R	M

Assigning and rotating roles helps to avoid both dominance by one student (the person with the pencil or keyboard has the real "power" in the group) and the free-rider effect. The roles also help groups that either avoid conflict or tend towards destructive conflict.

In well-functioning groups, all members share the roles of manager, checker, summarizer, and skeptic. The purpose of the roles is to give **you** a structure within which you can intervene to help groups that are not functioning well (see page 17).

4. In both discussion sections and lab, randomly call on individual students in a group to present their group's results. This person is *not* usually the Recorder/Checker for the group. In the beginning of the course, you can call on the individuals who seem most enthusiastic or involved. After students are familiar with group work, you can either call on the Skeptic/Summarizers or Managers, or call on individuals who seemed to be the least involved. This technique helps avoid both dominance by one student and the free-rider effect.
5. Group Processing: Set aside time at the end of a class session to have students discuss how well they worked together and what they could do to work together better next time (see pages 21-22).

At the beginning of the first semester, you should do group processing *every* class session. After two to three weeks (i.e., after students have worked in two different groups), you can reduce group processing to about once every two to three weeks, as it seems necessary (usually the first time new groups are working together).

6. Grading: Occasionally a group problem in discussion section is graded. Usually, the group test problem is given the day before the individual test. In the past we have found that with well designed problems (see Section IV-6) students tend to get their highest scores on the group tests. Although the group test questions are only about 15% of a student's grade in the course, this grading practice encourages students to work well together.

To avoid the free-rider effect, your team may want to set the rule that a group member absent the week before the group test question (i.e., s/he did not get to practice with her/his group) cannot take the group test question. Towards the end of the first semester, you could let the rest of the group members decide if the absent group member can take the group test problem.

To encourage students to work together in lab, your team could decide that each member of the group receives bonus points if all group members earn 80% or better on their individual lab problem reports.

Outline for Teaching a Discussion Section

This outline, which is described in more detail in the following pages, could serve as your "lesson plan" for each discussion session you teach.

Preparation Checklist:

- | | |
|---|--|
| <input type="checkbox"/> assign new roles | <input type="checkbox"/> photocopies of problem statement (one per person) |
| <input type="checkbox"/> assign new groups and roles (when appropriate) | <input type="checkbox"/> photocopies of answer sheet (one per group) |
| <input type="checkbox"/> solve the problem; decide what to have students put on board (diagram, plan, algebraic solution) | <input type="checkbox"/> photocopies of problem solution (one per person) |

	What the Students Do	What the TA Does
Opening Moves: 2 min.	<ul style="list-style-type: none"> • Sit in groups. • Read problem. • Checker/Recorder puts names on answer sheet. 	<ol style="list-style-type: none"> 0. Get to the classroom early. 1. Briefly introduce problem. 2. Pass out group problem and answer sheet. 3. Tell class the time they need to stop and remind managers to keep track of the time.
Middle Game	<ul style="list-style-type: none"> • Do the assigned problem: <ul style="list-style-type: none"> - participate in discussion, - work cooperatively, - check each other's work. 	<ol style="list-style-type: none"> 4. Take attendance. 5. Monitor groups and intervene when necessary. 6. A few minutes before you want them to stop, remind the students of the time and to finish working on their problem. Also pass out group functioning forms.
End Game: 5-10 min.	<ul style="list-style-type: none"> • Finish problem. • Check answer. • Participate in class discussion. 	<ol style="list-style-type: none"> 7. Select one person from each group to put their diagram/plan/algebraic solution on the board. 8. Lead a class discussion similarities and differences. 9. If necessary, lead a class discussion of group functioning. 10. Pass out the problem solution.

Detailed Advice for TAs about General Discussion Section Lesson Plan

0. Get to the classroom early.

When you get to the classroom, go in and lock the door, leaving your early students outside. The best time for informal talks with students is after the class.

Prepare the classroom by checking to see that there is no garbage around the room and that the chairs and desks are properly arranged. If you have changed groups, list the new groups and roles on the board at this time also. Let your students in when you are prepared to teach the discussion session.

1. Briefly introduce problem.

Spend a minute or two telling students about the problem - remind them what physical principles they have been discussing in class, and tell them why this particular problem has been chosen. **DO NOT LECTURE YOUR CLASS ON PHYSICS!**

Tell the students what you want them to put on the board when their time is up (diagram, solution plan, or algebraic solution).

2. Pass out group problem statement and answer sheet.

Give a copy of the problem to each student, but only one answer sheet to each group. This will help the students work in groups since they can only turn in one answer sheet for the group. The problem should have all the relevant equations given, **DO NOT ALLOW YOUR STUDENTS TO USE THEIR BOOKS OR NOTES!**

3. Tell class when (at what clock time) they need to stop and remind managers to keep track of time.

If you are planning on doing the group functioning worksheet, be sure to leave time at the end of class. Be sure to leave time for your end game!

4. Take attendance.

Take attendance as soon as the groups are working. Doing this early will cut down on tardiness.

5a. Diagnose initial difficulties with the problem or with group functioning.

Discussion Section Lesson Plan

Once the groups have settled into their task, spend about five minutes circulating and **observing** all groups. Try not to explain anything (except trivial clarification) until you have observed all groups at least once. This will allow you to determine if a whole-class intervention is necessary to clarify the task (e.g., I noticed that very few groups are drawing a careful force diagram. Be sure to draw and label a diagram. . . .).

5b. Monitor groups and intervene when necessary.

Establish a circulation pattern around the room. Stop and observe each group to see how easily they are solving the problem and how well they are working together. Don't spend a long time with any one group. Keep well back from students' line of sight so they don't focus on you. Make a mental note about which group needs the most help.

Intervene with the group that needs the most help. If you spend a long time with this group, then circulate around the room again, noting which group needs the most help. Keep repeating the cycle of (a) circulate and diagnose, (b) intervene with the group that needs the most help.

6. A few minutes before you want them to stop, remind the students of the time and to finish working on their problem.

Also pass out group functioning forms at this time (if necessary, about every 2 - 3 weeks). (Note: Another common teaching error is to provide too little time for students to process the quality of their cooperation. Students do not learn from experiences that they do not reflect on. If the groups are to function better next time, members must receive feedback, reflect on how their actions may be more effective, and plan how to be even more skillful during the next lab or discussion session.)

When you were an undergraduate, your instructors probably did not stop you to have a class discussion at the end of a recitation period. Doing this is one of the hardest things you will have to do as a TA. You may be tempted to let students keep working so that they can get as much done as possible, or to let them go home early so that they like you better. However, research has shown that students do not learn from their experiences unless they have the chance to process their information. One good way to do this is by comparing their results with the whole class.

Most students do not want to stop, and may try to keep working. If it is necessary, to make your students stop working you can warn them that you will not accept their paper if they keep working. You are in charge of the class, and if you make it clear that you want the students to stop, they will.

7. Select one person from each group to put their diagrams/solution plans/algebraic solution on the board.

Discussion Section Lesson Plan

In the beginning of the course, select students who are obviously interested, enthusiastic, and articulate. Later in the course, it is sometimes effective to occasionally select a student who has not participated in the discussion as much as you would like. This reinforces the fact that *all* group members need to know and be able to explain what their group did. Typically, the Recorder/Checker in each group is NOT selected.

8. Lead a class discussion of these results.

A whole-class discussion is commonly used to help students consolidate their ideas and make sense out of what they have been doing. Discussions serve several purposes:

- to summarize what students have learned;
- to help students find out what other students learned from the same problem;
- to produce discrepancies, which stimulate further discussion, thinking, or investigations.

These discussions should always be based on the groups, with individuals only acting as representatives of a group. This avoids putting one student "on the spot." The trick is to conduct a discussion about the results without (a) **telling** the students the "right" answer or becoming the final "authority" for the right answers, and (b) without focusing on the "wrong" results of one group and making them feel stupid or resentful. To avoid these pitfalls, you could try starting with general, open-ended questions such as:

- How are these results the same?
- How are these results different?

Then you can become more specific:

- What could be some reasons for them to be different?
- Are the differences important?

Always encourage an individual to get help from other group members if he or she is "stuck."

Encourage groups to talk to each other by redirecting the discussion back to the groups. For example, when a group reports their answer, ask the rest of the class to comment: "What do the rest of you think about that?" This helps avoid the problem of you becoming the final "authority" for the right answer.

9. If necessary, lead a class discussion about the group functioning.

Discussing group functioning occasionally is essential. Students need to hear difficulties other groups are having, discuss different ways to solve these difficulties, and receive feedback from you.

- Randomly call on one member of from each group to report either
 - one way they interacted well together, or
 - one difficulty they encountered working together, or
 - one way they could interact better next time.

Discussion Section Lesson Plan

- Add your own feedback from observing your groups (e.g., "I noticed that many groups are coming to an agreement too quickly, without considering all the possibilities. What might you do in your groups to avoid this?")

10. Pass out the solution.

Passing out the solution is important to the students. They need to see good examples of solutions to improve their own problem solving skills. Again, it is important to pass them out as the last thing you do, or the students will ignore anything that you say after you have passed them out. You cannot possibly be more interesting than the solutions.



Engineering and Science Departments Surveyed (1995)

<u>Department</u>	<u>% Students</u>
Mechanical Eng	31
Electrical Eng.	18
Civil Eng.	14
Chemical Eng.	11
Computer Sci.	11
Math	4
Chemistry	4
Material Sci.	1
Agricultural Eng.	1
Geology	1
Astrophysics	1



Survey Information

Faculty respondents were chosen by the directors of undergraduate studies within each engineering and science department.

Response rate was 67.6%
(50 out of 74)

Responses were weighted by the number of students in each department.
[Departments weighted equally]



Goals

Many different goals could be addressed through this course. Would you please rate each of the following goals in relation to its importance for your students on a scale of 1 to 5?

1 = unimportant 3 = somewhat important 5 = very important
2 = slightly important 4 = important

- | | | | | | |
|--|---|---|---|---|---|
| 1. Know the basic principles behind all physics (e.g. forces, ...) | 1 | 2 | 3 | 4 | 5 |
| 2. Formulate and carry out experiments | 1 | 2 | 3 | 4 | 5 |
| 3. Program computers to solve problems in the context of physics | 1 | 2 | 3 | 4 | 5 |
| 4. Etc, etc. | | | | | |



Highest Rated Goals

- | | |
|--|--------------|
| Solve problems using general <i>qualitative</i> logical reasoning within the context of physics. | 4.5
[4.7] |
| * Know the basic principles behind all physics (e.g. forces, conservation of energy). | 4.5
[4.7] |
| Solve problems using general <i>quantitative</i> problem solving within the context of physics. | 4.4
[4.6] |
| Apply the physics topics covered to new situations not explicitly taught by the course. | 4.2
[4.5] |
| Use with confidence the physics topics covered. | 4.2
[4.1] |
| * Know the range of applicability of the principles of physics (e.g. conservation of energy applied to fluid flow, heat transfer). | 3.9
[4.3] |



Goals Not Chosen

- Be familiar with a wide range of physics topics.
- Know the range of applicability of physics principles.
- Formulate and carry out experiments.
- Use modern measurement tools for physical measurements (e.g., oscilloscopes, etc.).
- Analyze data from physical measurements.
- Program computers to solve physics problems.
- Understand and appreciate “modern physics” (e.g., solid state, quantum mechanics, nuclei, etc.).
- Understand and appreciate the historical development and intellectual organization of physics.



Which Topics do Departments Want Taught?

- 80% Forces and Newton's Laws [85%]
- 64% Potential Energy and Conservation of Energy [63%]
- 32% Statics [13%]
- 32% Application of Newton's Laws [26%]
- 28% Units, Dimensions, and Vectors [26%]
- 24% Kinetic Energy and Work [15%]
- 24% Simple Harmonic Motion [22%]
- 16% DC Circuits [6%]
- 12% Waves [22%]
- 12% Superposition and Interference of Waves [16%]



What Topics Are Not Important? (not selected)

- Linear Motion
- Momentum and Collisions
- Angular Momentum
- Molecules and Gases
- Electric Potential
- Capacitors and Dielectrics
- Currents in Materials
- Faraday's Law
- Magnetism and Matter
- Magnetic Inductance
- AC Circuits

Notes: _____



The Dilemma

If the problems are simple enough to be solved moderately well using their novice strategy, then students see no reason to abandon this strategy -- even if a structured strategy works as well or better.

If the problems are complex enough so the novice strategy clearly fails, then students are initially unsuccessful at using the structured strategy, they revert back to their novice strategy.



Why We Use Cooperative Group Problem Solving

1. A structured problem solving strategy seems too long and complex to most students. Cooperative-group problem solving gives students a chance to practice the strategy until it becomes more natural.

2. Groups can solve more difficult problems than individuals, so students see the advantage of a logical problem-solving strategy early in the course.

3. Each individual can practice the planning and monitoring skills they need to become good individual problem solvers.





Why We Use Cooperative Group Problem Solving

4. Students get practice developing and using the language of physics -- "talking physics."



5. Students must deal with and resolve their misconceptions.
6. In whole-class discussions, students are less intimidated because they are not answering as an individual, but as a group.



The Spinoffs

Valued Characteristics in Employees in Engineering Companies

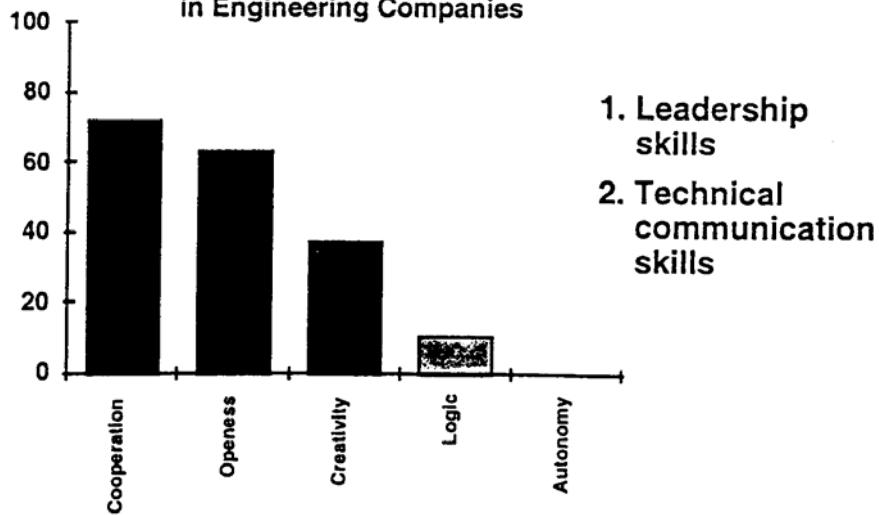



Laboratory Structure

Wgt %	The laboratory associated with this course is typically taught by graduate teaching assistants and could be structured in several ways.
36 [32]	1. A lab with well defined directions which verifies a physical principle previously explained to the students using the given apparatus.
27 [38]	2. A lab where the students are given a specific question or problem for which they must conduct an experiment with minimal guidance using the given apparatus.
10 [13]	3. A lab where the students are given a general concept from which they must formulate an experimental question, then design and conduct an experiment from a choice of apparatus.
27 [16]	Other



Recitation Structure

Wgt %	The recitation sections associated with this course are typically taught by graduate teaching assistants and could be structured in several ways.
7 [6]	1. Students ask the instructor to solve specific homework problems on the board.
15 [15]	2. Instructor asks students to solve specific homework problems on the board.
12 [15]	3. Instructor asks students to solve unfamiliar textbook problems, then discusses solution with the class.
43 [51]	4. Students work in small collaborative groups to solve real-world problems with the guidance of the instructor.
23 [13]	Other



Summary

1. **There is consensus among our engineering departments about what they want taught and how:**
 - **fundamental principles in depth (not many topics covered lightly)**
 - **comprehensive problem solving**
 - **collaborative learning**
 - **not inquiry labs**
- 2.. **Our engineers agree with the recommendations of many physics educators.**

Notes: _____

Instructor's Notes for Student Difficulties with Problem Solving (about 3.5 hours)

Activity #6: Differences in Expert and Novice Problem-solving

Activity #7: Methods Questions and Problem Solving

Activity #8: Practice Using a Strategy

Homework # 4: Using a Strategy to Solve a Context-rich Problem

The purposes of these activities are to: (1) introduce TAs to the kinds of difficulties their students will have solving quantitative problems, (2) analyze different recommended strategies and discuss how the strategies will help them become better coaches and graders, and (3) have the TAs practice solving a problem using an explicit strategy.

Activity #6: Differences in Expert-Novice Problem Solving (about 1.5 hrs)

- a) Motivation: "Your responsibilities as a TA include tutoring students who are having difficulty solving the homework problems during office hours, as well as "coaching" students as they solve problems in both the discussion section and the lab. To be an effective tutor and coach, you need to know (1) some common difficulties that students encounter solving problems, and (2) how to diagnose these difficulties from what they say and what they write, and (3) how to help students with their difficulties. We will be spending the next few days on these topics. First, let's have you solve a typical problem."

Activity #6a: Have the students solve the Cowboy Bob problem as quickly as they can (see page 179).

- b) "In the next part of the activity, you are going to compare how you solved the Graduate Written Exam problem earlier this morning with (i) how you solved the Cowboy Bob Problem, and (ii) how a beginning student solves the Cowboy Bob problem. You are going to make a flow chart of how you solve real problems." Show overhead of flow chart for starting a car in the winter.

Activity #6b: Assign new groups (roles by latest birthday). Explain task briefly (see pages 181 - 186). After TAs start, hand out two blank overheads & pen to each group.

- c) Closure: Show overheads from different groups. Discuss similarities and differences between their steps when they solve real problems (like a Graduate Written Exam problem) and when solve exercises (like the Cowboy Bob Problem). Relate these differences to their readings about differences in expert-novice problem solving.

Activity #7: Methods Questions and Problem Solving (about 0.5 hrs)

The purposes of this activity are to (1) introduce TAs to "explicit" problem solving strategies, and (2) to begin a discussion of how they can "coach" students.

- a) Motivation: "Jill Larkin recommended that students be taught an explicit problem-solving 'strategy' that helps students learn the processes an expert goes through when they solve real problems (not "exercises"). There are now many problem solving strategies in the literature — almost every textbook includes a problem-solving strategy. So which strategy is "best?" Are the strategies very similar, or are there fundamental differences? How would following a strategy make it easier to coach students?"
- b) Activity #7a: First review the strategies the TAs described in Activity #6b, focusing on the similarities. Then have TAs read Activity #7a (see pages 187- 194) which describes Fred Reif's Strategy and the Strategy from the *Competent Problem Solver*. Briefly compare and contrast:
 - The major point is that the strategies are more **similar** than different when actually executed. They each use different words to describe similar processes, and they have slight differences in emphases, but they all require students to draw diagrams, define variables explicitly, break the problem into sub-problems that can be solved while keeping track of the unknowns. Discuss the different ways the authors suggest students plan a solution.
 - It is also sometimes useful to return to the "chunking" idea. Writing was invented as a natural extension to short-memory, which for most people is between 4-7 "bits" of information. Experts have "chunked" many bits together, so they do not need to write as much — they have enough short-term memory to solve the problem. But beginning students have not chunked, so each little step is one of their 4-7 bits. They soon run out of short-term memory space, and literally forget what they did before *if it is not written down*. This is one reason why the authors of all the strategies insist that students explicitly write down a lot of information that an "expert" could probably keep in short-term memory.
- c) Activity #7b: Rotate roles and explain the task briefly (see pages 195- 197).
- d) Closure: Call on groups to contribute their answers about which steps of the strategy (in *The Competent Problem Solver*) the lab Methods Questions "coach" students through.

Finally, discuss a last question: How will knowledge of these strategies help you become a better problem-solving coach and grader?

Note: At some point, hopefully, someone will mention the technique of gradually moving from simple to more difficult problems. Sometimes TAs see the dilemma themselves -- simple problems reinforce the novice "plug-and-chug" strategy, while novices fail at the more difficult problems.

Activity #8: Practice Using a Problem-solving Strategy (about 45 min)

- a) Motivation: "You can not help students with the steps they need to go through unless you can "unchunk" yourself, and begin to think about and write down a lot more information than you are used to. So in this activity, you can practice using the strategy assigned to your group to solve a problem from the algebra-based course."
- b) Activity: Rotate roles, and have students turn to Activity Sheets (pages 199 - 202). Explain task to students: "Try to explicitly follow the roles assigned to you. When you teach the discussion sections, you will have students solve problems in cooperative groups and you will also assign roles. So try to follow the roles to experience what it feels like in a problem solving situation."
- c) Closure: Briefly discuss how difficult it was for them to follow the strategy and the roles. Did it help to have the manager read the steps?

Homework #4: Using a Strategy to Solve a Context-rich Problem (pages 203 - 206)

This homework assignment (see pages 203 - 206) gives TAs practice in using a problem-solving strategy. In addition, the students will later judge these context-rich problems for use as group practice problems or group test problems (see Homework #6, pages 227 - 230).

Some TAs find these problems difficult to solve. It is helpful to have students compare their solutions before you discuss what characteristics of a "hard" problem make it difficult for students to solve.

NOTES:

Below is a problem from an exam in Physics 1101 (algebra-based introductory course). Solve this problem as quickly as you can.

Cowboy Bob Problem: Because parents are concerned that children are taught incorrect science in cartoon shows, you have been hired as a technical advisor for the Cowboy Bob show. In this episode, Cowboy Bob, hero of the Old West, happens to be camped on the top of Table Rock in the Badlands. Table Rock has a flat horizontal top, vertical sides, and is 500 meters high. Cowboy Bob sees a band of outlaws at the base of Table Rock 100 meters from the side wall. The nasty outlaws are waiting to rob the Dodge City stagecoach. Cowboy Bob decides to roll a large boulder over the edge and onto the outlaws. Your boss asks you if it is possible to hit the outlaws with the boulder. Determine how fast Bob will have to roll the boulder to reach the outlaws.

TA Orientation 1999
Activity #6a (1 point)

Name: _____.

Notes:

Differences in Expert-Novice Problem Solving

GROUP TASKS:

1. Make a list or flow chart of all the steps (major decision points and/or actions) that you took to solve a "real problem" (the Graduate Written Exam Problem).
2. Make a list or flow chart of all the steps (major decision points and/or actions) that you took to solve an "exercise" (the Cowboy Bob Problem).
3. Make a list of all the ways an expert problem solver (e.g., you, a professor) solves a "real problem" *differently* than an "exercise."
4. What does Larkin recommend be done to help students become better problem solvers? How should this be done? What do you think of this idea?

COOPERATIVE GROUP ROLES:

Skeptic: Ask what other possibilities there are, keep the group from superficial analysis by not allowing the group to agree too quickly; ask questions that lead to a deeper analysis; agree when satisfied that the group has explored all possibilities.

Manager: Suggest a plan for answering the questions; make sure everyone participates and stays on task; watch the time.

Checker/Recorder: Ask others to explain their reasoning process so it is clear to all that their suggestions can be discussed; paraphrase, write down, and edit your group's answers to the questions.

TIME: 25 minutes.

One member from your group will be randomly selected to present your group's answers to Questions #1 and #2.

PRODUCT:

Activity #6b Answer Sheet.

Answer Sheet for Activity #6b

1. Examine your group solution to the Graduate Written Exam Problem. Make a flow chart of the major steps (decisions and/or actions) you took to solve the problem.

2. Now compare and contrast your group solution to the Graduate Written Exam (GWE) Problem and your individual solutions to the Cowboy Bob Problem. For you, as expert problem solvers, the GWE problem was a "real problem" -- one you did not know how to solve immediately -- and the Cowboy Bob Problem was probably more like an "exercise" -- a type of problem you have solved so many times before that you immediately knew how to approach the problem.

(a) Make a flow chart of the steps (major decisions and/or actions) you took to solve the Cowboy Bob Problem.

(b) How were your solution steps different for the real problem and the exercise?

3. For students in an introductory physics class (novice problem solvers), the Cowboy Bob Problem **IS A REAL PROBLEM**. Compare and contrast the attached novice solution to the Cowboy Bob Problem with your group solution to the GWE Problem.

Based on (a) your comparison of the solutions, and (b) the reading of Larkin (1979), make a list of all the ways that experts solve real problems (e.g., the GWE problem) *differently* than novices solve what is, for them, a real problem (e.g., the Cowboy Bob Problem).

Expert Solving Real Problem	Novice Solving a Real Problem

"Novice" Solution to Cowboy Bob Problem

2.

find v_0

$t = \frac{0}{A}$

$\theta = \tan^{-1} \frac{100}{500} = 11.3^\circ$

$v_f = v_0 + at$

$(5 = X)$

$X_y = v_0 t + \frac{1}{2} at^2 =$

$X_y = \frac{1}{2} at^2$

$500 =$

$t = \frac{X}{v}$

$t^2 = \frac{500m}{9.8 m/s^2}$

$X = vt$

$v = at$ $v = \frac{X}{t}$

$t^2 = (9.8 m/s^2)(500m)$

$X = at$

$t^2 = 51.0 s$

$\frac{X}{a} = t^2$

$t = 7.14 \text{ sec}$ $(7.14 \text{ sec} \times 9.8 \text{ m/s}^2 = 70 \text{ m})$

$500^2 + 100^2 = \sqrt{260000} =$

$= 509.9m$

$a = g = 9.8 m/s^2$

$X = X_0 + v_0 t + \frac{1}{2} at^2$

$X - X_0 = v_0 t + \frac{1}{2} at^2$

$\frac{X - X_0}{t} = v_0 + \frac{1}{2} at$

$\frac{0 - 500m}{7s} = \frac{1}{2} (9.8 m/s^2) (7s) = v_0$

$71.4 - 24.5 = 46.9 m/s$

$\tan \theta = \frac{v_{0x}}{71.4 m/s}$

$v_{0x} = 13.9 m/s$

$\frac{500m}{7sec} = v_y$

$v_y = 71.4 m/s$

he would have to roll the rock at 13.9 m/s

4. What does Larkin recommend be done to help students become better problem solvers? How should this be done? What do you think of this idea?

5. Optional: Shown below is a standard textbook solution to the Cowboy Bob problem. Discuss why this solution promotes continued use of a novice strategy (i.e., discourages the use of a more expert-like strategy).

"Choose a coordinate system with its origin at the point where the boulder goes off the cliff, with the x axis pointing horizontally to the right and the y axis vertically downward. The horizontal component of the initial velocity is:

$$v_{0x} = \frac{D}{t} = \frac{D}{\sqrt{2h/g}} = \frac{100 \text{ m}}{\sqrt{2(500 \text{ m}) / 9.8 \text{ m/s}^2}} = 10 \text{ m/s}$$

Since the fastest athletes run at about this speed, it is unlikely that Cowboy Bob would be able to push a big boulder this fast."

Comparing Two Problem Solving Strategies

Calvin and Hobbes / By Bill Watterson

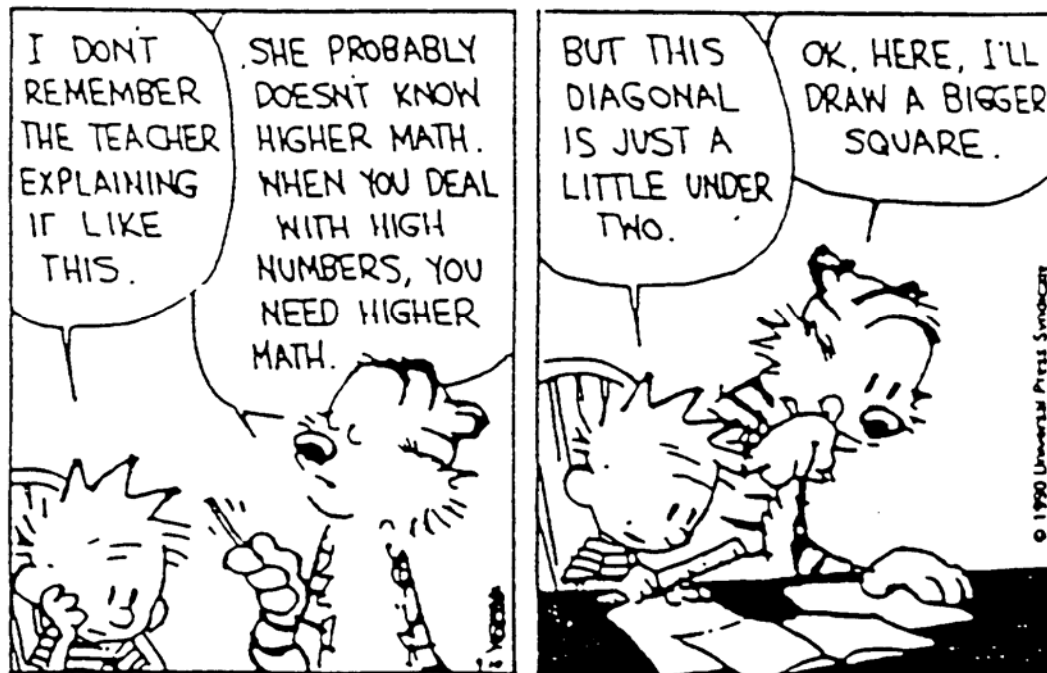

© 1990 Universal Press Syndicate

Strategy From *Understanding Basic Mechanics*, by Frederick Reif, (Wiley, 1995)

1. **Analyze the Problem:** Bring the problem into a form facilitating its subsequent solution.
 - Basic Description -- clearly specify the problem by
 - describing the *situation*, summarizing by drawing diagram(s) accompanied by some words, and by introducing useful symbols; and
 - specifying compactly the *goal(s)* of the problem (wanted unknowns, symbolically or numerically)
 - Refined Description -- analyze the problem further by
 - specifying the *time-sequence* of events (e.g., by visualizing the motion of objects as they might be observed in successive movie frames, and identifying the *time intervals* where the description of the situation is distinctly different (e.g., where acceleration of object is different); and
 - describing the situation in terms of important *physics concepts* (e.g., by specifying information about velocity, acceleration, forces, etc.).

 2. **Construct a Solution:** Solve simpler subproblems repeatedly until the original problem has been solved.
 - Choose subproblems by
 - examining the *status* of the problem at any stage by identifying the available known and unknown information, and the obstacles hindering a solution;
 - identifying available *options* for subproblems that can help overcome the obstacles; and
 - selecting a useful subproblem among these options.
 - If the obstacle is lack of useful information, then apply a *basic relation* (from general physics knowledge, such as $\mathbf{ma} = \mathbf{F}_{\text{TOT}}$, $f_k = \mu N$, $x = (1/2)a_x t^2$) to some *object or system* at some *time* (or between some times) along some *direction*.
 - When an available useful relation contains an unwanted unknown, eliminate the unwanted quantity by combining two (or more) relations containing this quantity.
- Note: Keep track of wanted unknowns (underlined twice) and unwanted unknowns (underlined once).
3. **Check and Revise:** A solution is rarely free of errors and should be regarded as provisional until checked and appropriately revised.
 - Goals Attained? Has all wanted information been found?
 - Well-specified? Are answers expressed in terms of known quantities? Are units specified? Are both magnitudes and directions of vectors specified?
 - Self-consistent? Are units in equations consistent? Are signs (or directions) on both sides of an equation consistent?

- Consistent with other known information? Are values sensible (e.g., consistent with known magnitudes)? Are answers consistent with special cases (e.g., with extreme or specially simple cases)? Are answers consistent with known dependence (e.g., with knowledge of how quantities increase or decrease)?
- Optimal? Are answers and solution as clear and simple as possible? Is answer a general algebraic expression rather than a mere number?

Problem: A 20-kg block is pulled along a horizontal surface by a cord that extends horizontally from the block over a frictionless and massless pulley at the end of the surface and then down to a hanging 10-kg block. The coefficient of friction between the 20-kg block and surface is 0.40. Determine the speeds of the blocks after moving 2 meters. They start at rest.

FOCUS the PROBLEM
Picture and Given Information

$M = 20 \text{ kg}$ $\mu = 0.40$
 $m = 10 \text{ kg}$ $d = 2 \text{ m}$
 $v_{01} = v_{02} = 0$

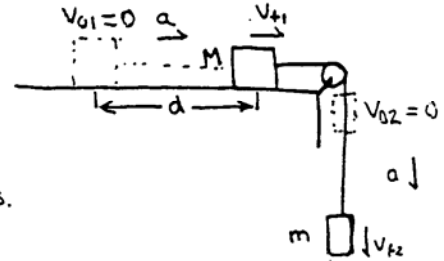

Question Find speed of blocks after moving 2 m from rest.

Approach

Use Kinematics to relate speeds to accelerations.
Use Newton's Laws to find constant accel.

PHYSICS DESCRIPTION
Diagram and Define Variables
Quantitative Relationships

$\rightarrow a_1$ $\rightarrow a_2$
 $x_0 = 0$ $x_2 = 2 \text{ m} = d$ $+x$
 $t_0 = 0$ $t_2 = ?$
 $v_{01} = 0$ $v_1 = ?$

$a_2 \downarrow$ $y_0 = 0$ $a_1 = a_2 = a$
 $t_0 = 0$ $t_2 = ?$ $v_1 = v_2 = v$
 $v_{02} = 0$ $y_2 = 2 \text{ m} = d$
 $a_2 \downarrow$ $t_2 = ?$ $v^2 = v_0^2 + 2ad$
 $v_2 = ?$

Target Variable(s) $V_1 = V_2 = V$

Block 1:

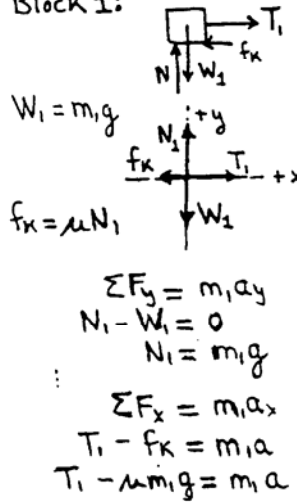

Block 2:

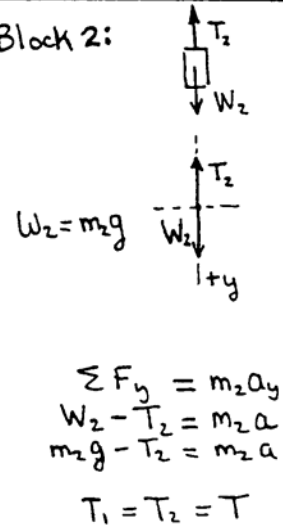

SOLVE the PROBLEM

Find v_f

① $v_f^2 = 2ad$

Find a : For Block 2

② $m_2 g - T = m_2 a$
Find T : For Block 1

③ $T - \mu m_1 g = m_1 a$

Solve ③ for T , put into ②

$m_2 g - (m_1 a + \mu m_1 g) = m_2 a$
 $g(m_2 - \mu m_1) = (m_2 + m_1) a$

Unknowns

v_f
 a

T

$a = \frac{(m_2 - \mu m_1)g}{m_1 + m_2}$
 $v_f^2 = \frac{2gd(m_2 - \mu m_1)}{m_1 + m_2}$
 $= \frac{2(9.8 \text{ m/s}^2)(2 \text{ m})(10 \text{ kg} - 0.40 \cdot 20 \text{ kg})}{10 \text{ kg} + 20 \text{ kg}}$
 $= 2.6 \text{ m}^2/\text{s}^2$

$\text{So } v_f = 1.6 \text{ m/s}$

EVALUATE the SOLUTION

Is Answer Properly Stated?

Yes - units in m/s

Is answer reasonable?

Yes - If m_2 were in free-fall, the velocity would be $v = \sqrt{2ad} = 6.3 \text{ m/s}$. I expected v to be less, and it is.

Is answer complete?

Yes

Strategy From *The Competent Problem Solver*, by K. Heller and P. Heller (U of MN, 1995)

1. **Focus on the problem:** Translate the words of the problem statement into a visual representation:
 - Draw a sketch (or series of sketches) of the situation.
 - Identify the known and unknown quantities and constraints.
 - State the problem that actually must be solved.
 - Decide a general approach to the problem-- what physics concepts and principles are appropriate to the situation and the assumptions that must be made. Decide what objects should be grouped into systems.

2. **Describe the Problem in Physics Terms (Physics Description):** Translate the sketch(s) into a physical representation of the problem:
 - Use identified principles to construct idealized diagram(s) with a coordinate system (e.g., vector component diagrams) for each object at each time of interest;
 - Decide on a coordinate system or systems;
 - Symbolically specify the relevant known and unknown variables. Symbolically specify the target variable(s) (e.g., find v_0 such that $h_{\max} \geq 10$ m);
 - Assemble the equations expressing the relevant fundamental principles and problem constraints in terms of the variables in your problem (e.g. $\sum F_x = T - f_k = ma_x$, $f_k = \mu N$, $\sum F_y = N - mg = 0$, $x = (1/2)a_x t^2$).

3. **Plan a Solution:** Translate the physics description into a series of appropriate mathematical equations:
 - Start with an equation that includes the target variable. (Keep track of unknowns.)
 - If there is another unknown in addition to the target variable, chose another equation (principle or constraint) that includes this unknown variable.
 - If there are no additional unknowns in this new equation, solve for the unknown variable.
 - If there are new unknowns in this new equation, identify another (unused) equation which includes the unknown variable and solve for the unknown.
 - Continue this process, until no new unknowns are generated.
 - Substitute the solution for the last unknown (which may still be in terms of other unknowns) into all previous equations containing that unknown. Continue this process until you reach the original equation with the target variable.
 - Solve the resulting equation for the unknown which should be the target variable.
 - Check the units of your algebraic equation for the target variable.

4. **Execute the Plan:**
 - Substitute specific values into the expression to obtain an arithmetic solution.

5. **Check and Evaluate:** Determine if the answer makes sense.
- check - is the solution complete?
 - check - is the sign of the answer correct, and does it have the correct units?
 - evaluate - is the magnitude of the answer unreasonable?

Problem: A 20-kg block is pulled along a horizontal surface by a cord that extends horizontally from the block over a frictionless and massless pulley at the end of the surface and then down to a hanging 10-kg block. The coefficient of friction between the 20-kg block and surface is 0.40. Determine the speeds of the blocks after moving 2 meters. They start at rest.

Picture and Given Information

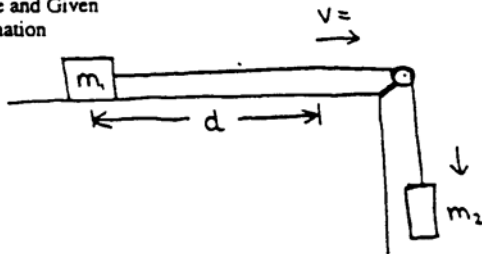

mass of block 1 = $m_1 = 20 \text{ kg}$
 mass of block 2 = $m_2 = 10 \text{ kg}$
 coefficient of friction = $\mu = 0.40$
 (friction) $d = 2 \text{ m}$

Question

Find speed of blocks after moving 2 m from rest.

Approach

Use kinematics to relate speeds to accelerations. Use Newton's laws to find the accelerations. All forces are constant, so accelerations are constant. Blocks move together, so they have the same acceleration.

Diagram and Define Variables

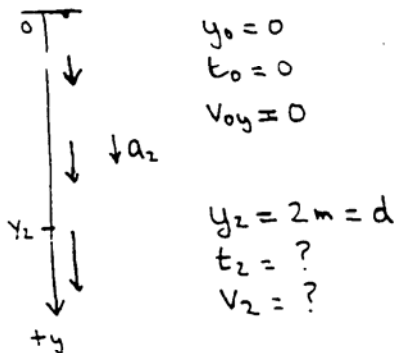
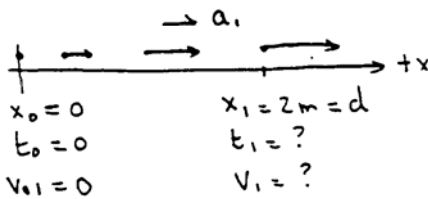

Target Variable(s)

v_1 and v_2

Quantitative Relationships

$$v_f^2 = v_0^2 + 2a\Delta r$$

$$\sum F_r = ma_r$$

$$f = \mu N$$

$$W = mg$$

Constraints

$$a_1 = a_2 = a$$

$$v_1 = v_2 = v$$

$$T_1 = T_2 = T$$

Block 1

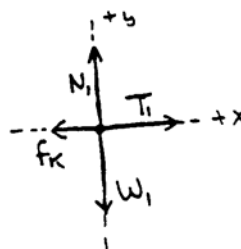
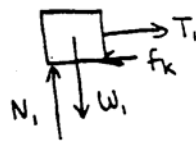

Block 2

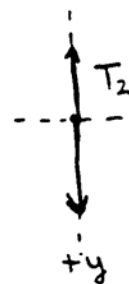
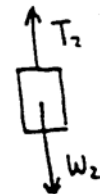

PLAN the SOLUTION

Construct specific algebraic equations

Find v:

$$v_f^2 = v_0^2 + 2a\Delta x$$

$$\textcircled{1} \quad v_f^2 = 2ad$$

Find a:

$$\text{Block 2} - \sum F_y = ma_y$$

$$m_2g - T = m_2a$$

$$\textcircled{2} \quad m_2g - T = m_2a$$

Find T:

$$\text{Block 1} - \sum F_x = ma_x$$

$$\textcircled{3} \quad T - f_k = m_1a$$

Find f_k:

$$\textcircled{4} \quad f_k = \mu N_1$$

Find N₁:

$$\text{Block 1} - \sum F_y = ma_y$$

$$\textcircled{5} \quad N_1 - m_1g = 0$$

Check for Sufficiency

Yes: 5 equations & 5 unknowns

Outline the Math Solution

Solve $\textcircled{5}$ for N_1 and put into $\textcircled{4}$ Solve $\textcircled{4}$ for f_k and put into $\textcircled{3}$ Solve $\textcircled{3}$ for T and put into $\textcircled{2}$ Solve $\textcircled{2}$ for a and put into $\textcircled{1}$ Solve $\textcircled{1}$ for v .Unknowns

v

a

T

f_kN₁**EXECUTE the PLAN**

Follow the Plan

$$\text{Solve } \textcircled{5}: \quad N_1 = m_1g$$

$$\text{Solve } \textcircled{4}: \quad f_k = \mu N_1 = \mu m_1g$$

$$\text{Solve } \textcircled{3}: \quad T - f_k = m_1a$$

$$T - \mu m_1g = m_1a$$

$$T = m_1a + \mu m_1g$$

$$\text{Solve } \textcircled{2}: \quad m_2g - T = m_2a$$

$$m_2g - m_1a - \mu m_1g = m_2a$$

$$m_2g - \mu m_1g = m_2a + m_1a$$

$$(m_2 - \mu m_1)g = (m_1 + m_2)a$$

$$\frac{m_2 - \mu m_1}{m_1 + m_2} g = a$$

$$\text{Solve } \textcircled{1}: \quad v^2 = 2ad$$

$$v = \sqrt{2gd \left(\frac{m_2 - \mu m_1}{m_1 + m_2} \right)}$$

Check units:

$$\int \left(\frac{\text{m}}{\text{s}^2} \right) (\text{m}) \left(\frac{\text{kg} - \text{kg}}{\text{kg} + \text{kg}} \right) = \sqrt{\frac{\text{m}^2}{\text{s}^2}} = \frac{\text{m}}{\text{s}}$$

OK

Calculate Target Variable(s)

$$v^2 = 2 \cdot 2\text{m} \cdot 9.8 \frac{\text{m}}{\text{s}^2} \left(\frac{10\text{kg} - (0.4)(20\text{kg})}{10\text{kg} + 20\text{kg}} \right)$$

$$v^2 = 2.6 \text{ m}^2/\text{s}^2$$

$$v = 1.6 \text{ m/s}$$

EVALUATE the SOLUTION

Is Answer Properly Stated?

Yes - velocity has proper units and sign

Is Answer Reasonable? Yes. If m_2 were in free-fall, the velocity would be $v = \sqrt{2gd} = 6.3 \text{ m/s}$. Expect v here to be less, and it is!

Is Answer Complete? Yes

Methods Questions and Problem Solving

GROUP TASKS:

1. **Individually** read the attached laboratory problem (Problem #1 from Lab 7 of Physics 1301, the first semester of the calculus-based introductory course).
2. For each Method Question below (Questions #1 - #8), identify the corresponding step (or steps) from the strategy outlined in *The Competent Problem Solver* (see pages 1-3 through 1-5).

COOPERATIVE GROUP ROLES:

Skeptic: Ask what other possibilities there are, keep the group from superficial analysis by not allowing the group to agree too quickly; ask questions that lead to a deeper analysis; agree when satisfied that the group has explored all possibilities.

Manager: Suggest a plan for answering the questions; make sure everyone participates and stays on task; watch the time.

Checker/Recorder: Ask others to explain their reasoning process so it is clear to all that their suggestions can be discussed; paraphrase, write down, and edit your group's answers to the questions.

TIME: 10 minutes.

One member from your group will be randomly selected to present your group's answers to Questions #1 and #2, or #3.

PRODUCT:

Activity #7b Answer Sheet.

PROBLEM #1: MOMENT OF INERTIA OF A COMPLEX SYSTEM

While examining the engine of your friend's snowblower you notice that the starter cord wraps around a cylindrical ring of metal. This ring is fastened to the top of a heavy, solid disk, "a flywheel", and that disk is attached to a shaft. You are intrigued by this configuration and wonder how to determine its moment of inertia. Your friend thinks that you just add them up to get the moment of inertia of the system. To test this idea you decide to build a laboratory model described below to determine the moment of inertia of a similar system from its motion. You think you can do it by just measuring the acceleration of the hanging weight.



Determine the moment of inertia from the acceleration of the hanging weight in the equipment described below. Is the moment of inertia of a system just the sum of the moments of inertia of the components?

EQUIPMENT

For this problem, you have a disk which is mounted on a sturdy stand by a metal shaft. Below the disk on the shaft is a metal spool to wind string around. There is also a metal ring that sits on the disk so both ring and disk share the same rotational axis. A length of string is wrapped around the spool, then passes over a pulley lined up with the edge of the spool. A weight is hung from the other end of the string so that the weight can fall past the edge of the table.

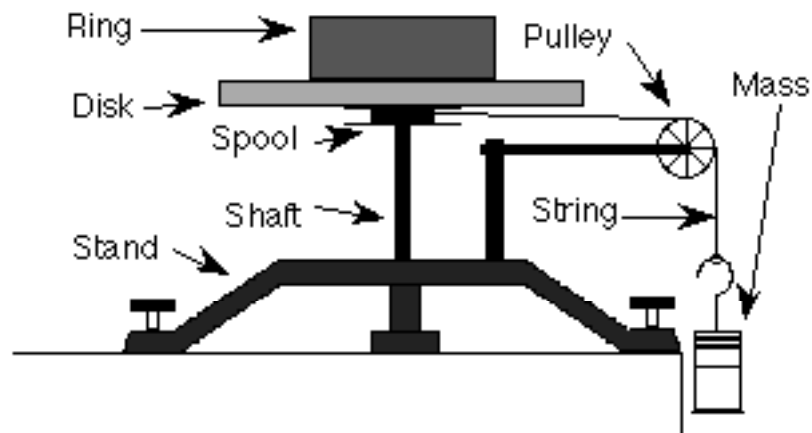

As the hanging weight falls, the string pulls on the spool, causing the ring/disk/shaft/spool system to rotate. You can analyze the motion using a video camera connected to a computer. You will also have a meterstick and a stopwatch.

PREDICTION

Calculate that the moment of inertia of the system as a function of the acceleration of the hanging weight and the radius of the spool.

Using the table of moments of inertia in your text, write an expression for the total rotational inertia of the components of the system in terms of their masses and radii.

Will these two methods agree? If not, which one, if any, is correct?

METHOD QUESTIONS

To test your predicted equation, you need to determine how to calculate the moment of inertia of the system from the quantities you can measure in this problem. It is helpful to use a problem-solving strategy such as the one outlined below to solve for your prediction.

TASK:

For each Method Question below (Questions #1 - #8), identify the corresponding step (or steps) from the strategy outlined in *The Competent Problem Solver* (see pages 1-3 through 1-5).

Step	Problem-solving Steps
-------------	------------------------------

<p>1. Draw a side view of the equipment. Draw the velocity and acceleration vectors of the weight. Add the tangential velocity and tangential acceleration vectors of the outer edge of the spool. Also, show the angular acceleration of the spool. What is the relationship between the acceleration of the string and the acceleration of the weight if the string is taut? What is the relationship between the acceleration of the string and the tangential acceleration of the of the outer edge of the spool if the string is taut?</p>	
<p>2. Since you want to relate the moment of inertia of the system to the acceleration of the weight, you probably want to consider a dynamics approach (Newton's 2nd Law) especially using the torques exerted on the system. It is likely that the relationships between rotational and linear kinematics will also be involved.</p>	
<p>3. To use torques, first draw vectors representing all of the forces which could exert torques on the ring/disk/shaft/spool system. Identify the objects that exert those forces. Draw pictures of those objects as well showing the forces exerted on them.</p>	

<p>4. Draw a free-body diagram of the ring/disk/shaft/spool system. Show the locations of the forces acting on that systems. Label all the forces. Does this system accelerate? Is there an angular acceleration? Check to see you have all the forces on your diagram. Which of these forces can exert a torque on the system? Identify the distance from the axis of rotation to the point where each force is exerted on the system. Write down an equation which gives the torque in terms of the force that causes it. Write down Newton's second law in its rotational form for this system. Make sure that the moment of inertia includes everything in the system.</p>	
<p>5. Use Newton's 3rd Law to relate the force of the string on the spool to the force of the spool on the string. Following the string to its other end, what force does the string exert on the weight? Make sure all the forces on the hanging weight are included in your drawing.</p>	
<p>6. Draw a free-body diagram of the hanging weight. Label all the forces acting on it. Does this system accelerate? Is there an angular acceleration? Check to see you have all the forces on your diagram. Write down Newton's second law for the hanging weight. How do you know that the force of the string on the hanging weight is not equal the weight of the hanging weight?</p>	

<p>7. Is there a relationship between the two kinematic quantities that have appeared so far: the angular acceleration of the ring/disk/shaft/spool system and the acceleration of the hanging weight? To decide, examine the accelerations that you labeled in your drawing of the equipment.</p>	
<p>8. Solve your equations for the moment of inertia of the ring/disk/shaft/spool system as a function of the mass of the hanging weight, the acceleration of the hanging weight, and the radius of the spool. Start with the equation containing the quantity you want to know, the moment of inertia of the ring/disk/shaft/spool system. Identify the unknowns in that equation and select equations for each of them from those you have collected. If those equations generate additional unknowns, search your collection for equations which contain them. Continue this process until all unknowns are accounted for. Now solve those equations for your target unknown.</p>	

Notes:

Practice Using a Problem Solving Strategy

GROUP TASKS:

1. Use the strategy in *The Competent Problem Solver* to solve the problem on the following page. This will give you practice using a strategy (without automatically skipping many steps). Be very explicit in what you write down.
2. Try to follow the problem-solving roles explicitly.

COOPERATIVE GROUP ROLES:

Skeptic: Follow the sample solution for the problem-solving strategy assigned to your group and be sure no steps are skipped or misinterpreted; at each step, ask what other possibilities there are; keep the group from superficial analysis of the problem by not allowing the group to agree too quickly; ask questions that lead to a deeper analysis; agree when satisfied that the group has explored all possibilities.

Manager: Read the problem-solving strategy aloud so that the group can follow the strategy step by step; make sure everyone participates and stays on task; watch the time.

Checker/Recorder: Ask others to explain their reasoning process so it is clear to all that their suggestions can be discussed; paraphrase, write down, and edit your group's solution to the problem following the format for the sample solution.

TIME: 20 minutes.

One member from your group will be selected to draw your group's physics diagram and equations on the board.

PRODUCT:

Complete the Answer Sheet for Activity #8.

Group Problem: You are flying to Chicago when the pilot tells you that the plane can not land immediately because of airport delays and will have to circle the airport. This is standard operating procedure. She also tells you that the plane will maintain a speed of 400 mph at an altitude of 20,000 feet, while traveling in a horizontal circle around the airport. To pass the time you decide to figure out how far you are from the airport. You notice that to circle, the pilot "banks" the plane so that the wings are oriented at 10° to the horizontal. An article in your in-flight magazine explains that an airplane can fly because the air exerts a force, called "lift," on the wings. The lift is always perpendicular to the wing surface. The magazine article gives the weight of the type of plane you are on as 100×10^3 pounds and the length of each wing as 150 feet. It gives no information on the thrust of the engines or the drag of the airplane.

The only formulas and constants which may be used for this problem are those given below. You may, of course, derive any expressions you need from those that are given. If in doubt, ask.

Useful Mathematical Relationships:

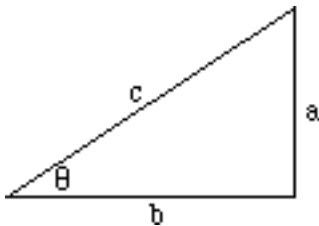

For a right triangle: $\sin \theta = \frac{a}{c}$, $\cos \theta = \frac{b}{c}$, $\tan \theta = \frac{a}{b}$,

$$a^2 + b^2 = c^2, \sin^2 \theta + \cos^2 \theta = 1$$

For a circle: $C = 2\pi R$, $A = \pi R^2$

For a sphere: $A = 4\pi R^2$, $V = \frac{4}{3} \pi R^3$

If $Ax^2 + Bx + C = 0$, then $x = \frac{-B \pm \sqrt{B^2 - 4AC}}{2A}$

Fundamental Concepts:

$$\bar{v}_r = \frac{\Delta r}{\Delta t}$$

$$v_r = \lim(\Delta t \rightarrow 0) \frac{\Delta r}{\Delta t}$$

$$\Sigma F_r = ma_r$$

$$\bar{a}_r = \frac{\Delta v_r}{\Delta t}$$

$$a_r = \lim(\Delta t \rightarrow 0) \frac{\Delta v_r}{\Delta t}$$

Under Certain Conditions:

$$\bar{v}_r = \frac{(v_{ir} + v_{fr})}{2}$$

$$a = \frac{v^2}{r}$$

$$F = \mu_k F_N$$

$$F \leq \mu_s F_N$$

Useful constants: 1 mile = 5280 ft, 1 ft = 0.305 m, $g = 9.8 \text{ m/s}^2 = 32 \text{ ft/s}^2$, 1 lb = 4.45 N,

FOCUS the PROBLEM Picture and Given Information

Question(s)

Approach

DESCRIBE the PHYSICS
Diagram(s) and Define Quantities

Target Quantity(ies)

Quantitative Relationships

PLAN the SOLUTION

Construct Specific Equations

EXECUTE the PLAN

Calculate Target Quantity(ies)

EVALUATE the ANSWER

Is Answer Properly Stated?

Is Answer Unreasonable?

Is Answer Complete?

(extra space if needed)

Check Units

Teaching the Problem-solving Laboratories

Related Readings -- Articles

Toothacker, W. S. (1983). A critical look at introductory laboratory instruction. *American Journal of Physics*, 51, pages 516-520.

Smith, K., Johnson, D. and Johnson, R. Cooperation in the College Classroom. Handout. University of Minnesota. pages 2-6 and 14-16.

Heller, P., Hollabaugh, M. (1992). Teaching problem solving through cooperative grouping. Part 2: Designing problems and structuring groups. *American Journal of Physics*, 60, pages 640-644

Related Readings -- Instructor's Lab Manual

The following readings from the Instructor's Lab Manual, assigned after the completion of Activity #5, are included in this booklet:

Frequently Asked Questions (FAQ) About the Problem-solving Labs (pages 141 - 147)

Outline for Teaching a Laboratory (page 148)

Detailed Advice for Teaching the Labs (pages 149 - 153)

Activities

The TAs spend about 16 hours spread over three weeks learning the rationale and structure of the problem-solving labs, becoming familiar with the content of the labs, the equipment, and the kind of data to expect, and peer teaching one lab problem.

Instructor's Notes for Introduction to Problem-solving Labs (about 16 hours total)

Activity #9: Demonstration Lab (about 3 hours)

Since our labs require non-traditional teaching, we have found it useful to have an experienced TA model how to (1) introduce the lab structure to students, and (2) conduct a typical lab (see pages 123 - 134). The TAs imagine they are undergraduate students in the lab, but they also observe closely the actions of the instructor. The instructor stops periodically to have the TAs reflect on the rationale or purpose of each instructor action (see Activity Sheets on pages 115 - 120). The lesson plan for this activity is included as part of the activity.

After this session, TAs read three handouts in their Instructor's Handbook. These handouts are included on pages 133 - 145 of this guide:

- The "FAQ About the Problem-solving Labs" reinforces the goals and rationale for the labs (pages 141 - 147).
- The *Outline for Teaching a Laboratory* provides the TAs with a brief lesson plan from which they can teach (page 148).
- The *Detailed Advice for Teaching the Labs* describes in detail the major instructor actions during a problem-solving lab, including how to monitor and intervene with groups (pages 149 - 153).

The TAs are expected to use these handouts to prepare for the peer-teaching activity (Activity #10 see page 137).

NOTES:

Demonstration of Laboratory Instruction

Today, a mentor TA will demonstrate how to teach a problem-solving laboratory session at the University of Minnesota. The goals of this activity are for you to learn:

- the structure of the problem-solving and exploratory labs you will be teaching;
- how to introduce the lab structure and rules to your students; and
- the rationale for each teaching action in the lab sessions.

During the demonstration, another mentor TA will observe the teacher. At the end of the demonstration, the teacher will be mentored by the observer. Compare your impressions with those of the mentor.

GROUP TASKS:

1. Participate in the laboratory demonstration as undergraduates might.
2. Periodically, we will stop the demonstration. Discuss the reasons for each part of the lesson plan and write the reasons under "Rationale" on the attached lesson plan. These reasons will then be shared and expanded upon by the class and instructors.
3. Work on the assigned laboratory problems and be prepared to discuss your results.

COOPERATIVE GROUP ROLES:

Skeptic: Ask what other possibilities there are, keep the group from superficial analysis by not allowing the group to agree too quickly; ask questions that lead to a deeper analysis; agree when satisfied that the group has explored all possibilities.

Manager: Suggest a plan for answering the questions; make sure everyone participates and stays on task; watch the time.

Checker/Recorder: Ask others to explain their reasoning process so it is clear to all that their suggestions can be discussed; paraphrase, write down, and edit your group's rationale.

TIME: 3 hours.

PRODUCT:

Complete the rationale in the attached lesson plan.

	Opening Moves	Rationale
<p><u>Middle</u></p> <p>2 min.</p> <p>5 min.</p> <p>1 min.</p> <p>3 min.</p> <p>5 min.</p> <p>2 min.</p>	<p>* We will work in cooperative groups and switch groups 5 or 6 times during the semester. Briefly describe roles and assignments on note cards.</p> <p>Why work in groups?</p> <ul style="list-style-type: none"> • Lets you concentrate on physics by assigning some of the tasks you normally do to others. <ul style="list-style-type: none"> • Recorder doesn't think about time, etc. • Everyone needs to think physics • Ed. Res. says this is the best way to learn -- Learn best by teaching others <p>Why switch groups? Make friends in a big Univ.</p> <p>Pass out Group Role sheets: What to say.</p> <p>Practice activity: You have overslept. You have ten minutes before your bus leaves.</p> <ul style="list-style-type: none"> • This is a real problem that you typically handle on your own. • In this activity you should see how all the roles come into play to help you solve the problem. Imagine that you have three brains helping you organize this morning's chaos. • Make a list of things you could do before the bus leaves and things you normally would do, but have decided that there just isn't time. <p>Intervention words: S: Can you really get this much stuff done? M: Keep calling out the time</p> <p>Discussion points: Who skipped showering? Who skipped breakfast? Who remembered bus fare?</p>	

* First lab or as necessary

	Middle Game	Rationale
<p><u>Middle: Part 2</u> 10 min.</p> <p>5-10 min</p> <p>5 min.</p> <p>10 min.</p>	<p>* I'd like to quickly review the introduction to the labs found in the first six pages of the lab instructions.</p> <ul style="list-style-type: none"> • Have groups come to consensus about predictions for assigned lab problem(s). <ul style="list-style-type: none"> - Check individual predictions • Walk around room and <ul style="list-style-type: none"> - diagnose difficulties with physics; - diagnose difficulties in groups; - select who will go up to the board with which predictions or method questions. • Call those people to the board. • Look for difficulties in the explanations and follow-up. 	
<p><u>End</u> 1 min.</p>	<ul style="list-style-type: none"> • Divide class in half -- one-half does each problem. • They will have 30 minutes. • Set timer. 	

NOTES:

*** First lab or as necessary**

	Middle Game	Rationale
<p><u>Beginning</u></p> <p style="text-align: center;">2 min.</p>	<ul style="list-style-type: none"> • Return cars and springs to the class. • Watch class from front of room: Don't answer questions. Is class able to proceed? • Stop class if everyone is off task. 	
<p><u>Middle</u></p>	<ul style="list-style-type: none"> • Walk once through groups without stopping: Diagnose problems with physics; Diagnose problem with group functioning. Prioritize who needs the most help. Is entire class confused on the same thing? • Intervene first with group that needs most help, and so on. Occasionally walk through groups without stopping and repeat step above. • Be sure groups are completing all parts of problems. • Assign second problem as needed. • Start grading journals and assigning problems to write up. 	
<p><u>End</u></p> <p style="text-align: center;">last 5 min.</p>	<ul style="list-style-type: none"> • Finish grading journals and assigning problems. • Announce 5 minutes left. Find a good stopping place. Have the students clean up. • Pass out <i>Group Functioning</i> sheets. 	

NOTES:

	End Game	Rationale
<p><u>Beginning</u></p> <p style="text-align: center;">10 min.</p>	<ul style="list-style-type: none"> • Select one person from each group to put results on the board. • Collect and count cars and springs. • Watch from rear of room: Make sure everyone is paying attention. Prompt discussion as needed. 	
<p><u>Middle</u></p> <p style="text-align: center;">5 min.</p> <p style="text-align: center;">5 min.</p>	<ul style="list-style-type: none"> • Group Activity: Fill out the <i>Group Functioning</i> sheets. • Select "good" response from one group, a "problem" and "specific action" from another group. Repeat until every group has spoken twice. • Assign problems/predictions for next week. 	
<p><u>End</u></p> <p style="text-align: center;">Post -bell</p>	<ul style="list-style-type: none"> • Erase black-board. • Straighten what did not get straightened. • Do not allow next class to enter. 	

NOTES:

Practice Lab Teaching

As a way of preparing to teach the University of Minnesota's problem-solving labs, you will have the opportunity to practice teach one lab problem to your peers. You have already been assigned to a group, and your group has been assigned one of the four labs to prepare. For four afternoons in the next week or two, the mentor TAs will supervise the practice teaching of the four labs.

There are two goals for this peer teaching. One is for you to get practice "running through" labs, so that you have a sense of what it feels like to keep track of time, supervise a room full of people doing a lab, and lead a discussion. The other goal is for you to become familiar and comfortable with the equipment and typical results for the problem-solving labs.

Each afternoon will be structured as follows:

- The mentor TAs may need to make some brief announcements.
- The "practice teachers" for one afternoon will teach, and the practice teachers for the other three afternoons will act like undergraduate students. This means that you are supposed to come to class with the Predictions and Method Questions completed and be ready to participate in discussions and take data (see Homework #3, #5, #6 and #8 in the Syllabus).
- Each practice teacher will have about 60 minutes to teach one lab problem, or 30 minutes to teach a discussion session. During that time, they will practice the instructional technique of coaching: they will let their "students" discuss their predictions in groups and put some on the board (lab), lead a whole-class discussion of predictions (lab), supervise the taking of data or working of the problem, have results or answers put on the board, and lead a discussion of those results or answers.
- The practice teachers for lab will then pass out the data and results that THEY had previously prepared for their lab problem (1 point). The practice teachers for discussion will hand out the solution to the problem.
- The "students" for this lab or discussion session will give each practice teacher written feedback.
- After all the TAs have practice-taught on a day, they will stay and be mentored by the mentor TA.

These afternoon sessions should run between 2 and 3 hours.

Lab Preparation: It is assumed that you have already done the Predictions and Method Questions for the lab to which you have been assigned. Today, during your preparation time, discuss with your group the answers to these questions. Then, with your group, work through all the lab problems, collect data, and analyze your results. Your group will be the "expert" on this lab, and should be able to answer questions from other TAs. If you need help with anything, ask the mentor TA working with you. Have fun!

Discussion Session Preparation: Your group will need to choose or write a context-rich problem for your students to work on in practice discussion session. You can pick a problem from the pink Instructor's Handbook and modify it if you want to, or you can try to write a problem. Your group will need to have the solution to the problem written up and ready to hand out to your students.

Grading for Homework #3, #5, #7 & #8 When You Are a Student:

Labs:

Predictions and Methods Questions	1 point
Journal	1 point
Written feedback to Practice Teachers	1 point

Recitation:

Participation	2 points
Written feedback to Practice Teachers	1 point

Grading Sheet for Homework #3, #5, #7 or #8 When You Are the Practice Teacher: Lab

What the TA Does	TA initials:				
<p>Opening Moves: 10 min</p>	<p>0. Get to the laboratory classroom early.</p> <p>1. Check individual predictions in grade book.</p> <p>2. Diagnose major conceptual problems.</p> <p>3. Lead class discussion about <i>reasons</i> for group predictions</p> <p>4. Assign/rotate roles (for computer labs, recorder has the keyboard).</p> <p>5. Tell students the class time they need to stop and remind managers to keep track of time.</p>				
<p>Middle Game</p>	<p>6. Diagnose problems</p> <p>7. Intervene when necessary</p> <p>8. When appropriate, grade journals</p> <p>9. Ten minutes before you want them to stop, tell students to find a good stopping place and clean up their area. Make sure you are finished grading journals. Also pass out group functioning forms at this time.</p>				
<p>End Game: 10 min</p>	<p>10. Select one person from each group to put their results or data on the board.</p> <p>11. Lead a class discussion of these results.</p> <p>12. Lead a class discussion of group functioning, if necessary. (This should be done at the end of the day and the decision should be a team decision. You should also be able to explain your decision to the mentor TA)</p> <p>13. Tell students what exercise to do predictions for next week.</p> <p>14. Erase the board.</p>				
	Total:				
	Grade:				

<u>Total Steps Performed</u>	<u>Grade</u>
14 - 15	3 points
11 - 13	2 points
7 - 10	1 point
0 - 6	0 points

**Grading Sheet for Homework #3, #5, #7 or #8
When You Are the Practice Teacher: Discussion Session**

What the TA Does	TA Initials:				
Opening Moves: 10 min	0. Get to the classroom early. 1. Briefly introduce problem. 2. Pass out group problem and answer sheet. 3. Tell class the time they need to stop and remind managers to keep track of the time.				
Middle Game	4. Take attendance. 5. Monitor groups and intervene when necessary. 6. A few minutes before you want them to stop, remind the students of the time and to finish working on their problem. Also pass out group functioning forms.				
End Game: 10 min	7. Select one person from each group to put their diagram/plan/algebraic solution on the board. 8. Lead a class discussion similarities and differences. 9. If necessary, lead a class discussion of group functioning. 10 Pass out the problem solution.				
	Total:				
	Grade:				

<u>Total Steps Performed</u>	<u>Grade</u>
9-10	3 points
7-8	2 points
6	1 point
0 - 5	0 points

Instructor's Notes for Characteristics of Good Problems (about 2 hours)

Activity #11: Designing a Group Problem

Homework #6: Judging Group Problems

One of the most difficult aspects of cooperative-group problem solving is designing good group problems. If the problems are too easy, then there is no point in working in groups, and students will complain. If the problems are *mathematically* complex or difficult, then again, they are better done by individuals, not groups.

Professors will often ask their TAs to critique a draft of a group problem that the professor has developed, or to construct a first draft of a group problem (in pairs) for the team to critique. The purposes of these activities are to: (1) introduce the TAs to the criteria for good group problems, (2) give them practice in designing a group problem, and (3) give them practice using criteria to judge whether a draft problem is a good group problem.

Activity #11: Designing a Group Problem (about 2 hours)

- a) Motivation/Introduction: "You may be asked by your professor to either construct a first draft of a group problem (in teams of two), or to critique a draft of a problem the professor developed. It is very difficult to design a good group problem. It turns out that you cannot just use a standard textbook problem."

Show the first overhead (see page 211) and elicit some responses from the TAs. This is a review of the Heller and Hollabaugh (1992) article. Then show overheads about appropriate group tasks (overheads #2 and #3 on page 212).

Show Overhead #4 (page 213). Ask the TAs why this version of the textbook problem is a better group problem. Discuss. Then show Overheads #5 and #6 (page 214).

Show Overhead #7 (page 215) and ask the TAs to list which of the five characteristics of a context-rich problem are missing from this textbook problem. Discuss. Then show Overhead #8 (page 216), which is the context-rich version of this textbook problem.

Repeat this process for Overheads #9 & #10 and Overheads #11 & #12 (pages 217 - 220).
"So now let's try to design our own group problem from a textbook problem."

- b) Pass out the Activity Sheets (see page 221 - 225), assign roles, and briefly explain the task: the TAs are to start with a textbook problem and turn it into a context-

Instructor's Notes for Characteristics of Group Problems

rich problem. Each context-rich problem should be written on a large sheet of paper and taped to a wall. Be sure to assign the same problem to at least three groups, so the TAs can see the same physics applied to different contexts.

- c) Closure: After the groups have put their context-rich problems on the walls, have the TAs walk around and read each problem. The groups take turns giving one "piece of advice" to another group about how to make their problem better.

Homework #8: Judging Group Problems (about 0.5 hours)

The purpose of this activity is to have TAs begin to use some criteria to judge whether a problem is a good individual problem, group practice problem (which can be completed in about 25 minutes), or a good group test problem (which requires a full 50 minutes to complete).

- a) Motivation: "You have designed a problem, but you also need to be able to critique a draft problem to decide if it can be used as a group practice problem, a group test problem, or whether it would be best to use it as an individual homework or quiz problem. This homework activity will help you learn some criteria you can use to judge problems."
- b) Pass out the Activity sheets (see pages 227-230). Introduce the judging criteria and model, by thinking out loud, how to judge the two example problems.
- c) During the next class session, review the judgments made by the TAs and discuss any large discrepancies between their judgments and your own. We have found that there are usually two factors that account for a wide disparity of judgments either among the TAs or between you and the TAs. First, some TAs (particularly foreign TAs) tend to solve the problems in sophisticated ways that students in introductory courses would not use. For example, problem #1 (Oil Tanker Problem) is rejected by some TAs because it can be solved with one equation *in a moving frame of reference*. In fact, this problem is a difficult group problem for students who have just started to study linear kinematics in the first weeks of an introductory course. The second factor that sometimes leads to a large disparity in judgments is the inability of some TAs to solve the problems themselves. For example, TAs who do not understand Newton's Third Law have difficulty judging problem #4 (Ice Skating problem).

Instructor's Notes for Characteristics of Group Problems

Key to Decisions:

Problem and Timing	Difficulty Rating	Decision
<u>Example #1- Skateboard Problem:</u> Assume that students have just started to study the conservation of energy and momentum in collisions.	Rating = 2 <ul style="list-style-type: none"> • no explicit target variable • assumptions needed 	This would make a good group practice problem, or a medium-difficult individual test problem. It is too easy for a group test problem.
<u>Example #2 - Log Problem:</u> Assume that students have just finished studying the application of Newton's laws.	Rating = 2 <ul style="list-style-type: none"> • no explicit target variable? • vector components 	This is too easy for a group practice or test problem. It would make a good medium-difficult individual test problem.
1. <u>Oil Tanker Problem:</u> Assume students have just started studying linear kinematics (i.e., the definition of average velocity and average acceleration).	Rating = 3 - 4 <ul style="list-style-type: none"> • more information • more than two subparts • assumptions needed • sim. eqs. or calculus 	Since this problem would be used at the beginning of the course, it would be a <i>very</i> difficult group test problem. It gives students practice visualizing a physical situation, drawing a coordinate diagram, and carefully defining variables.
2. <u>Ice Skating Problem:</u> Assume students have just finished studying the application of Newton's Laws of Motion.	Rating = 2 <ul style="list-style-type: none"> • difficult physics (Newton's third law) • vector components) 	This would make a good easy to medium-difficult individual test problem. Since students are finishing their study of Newton's Laws, it is too easy for a group practice or group test problem. (Note: It would be a very good group practice problem if students were just starting their study of Newton's Laws)
3. <u>Safe Ride Problem:</u> Assume that students have just finished studying forces and uniform circular motion.	Rating = 4 <ul style="list-style-type: none"> • difficult physics (circular motion) • no explicit target variable • vector components • trig. to eliminate unknown 	This would make a good group practice or test problem. It could also be used as a difficult individual test problem.
4. <u>Cancer Therapy Problem:</u> Assume students have just finished studying the conservation of energy and momentum.	Rating = 3 <ul style="list-style-type: none"> • unfamiliar context • vector components • sim. eqs. or calculus 	This would make a good group test problem. The algebra is too long/complex for a group practice problem. It could also be used as a difficult individual test problem.

Instructor's Notes for Characteristics of Group Problems

<p>5. <u>Kool Aid Problem</u>: Assume that students have just finished studying calorimetry.</p>	<p>Rating = 4 - 5</p> <ul style="list-style-type: none">• more than two subparts??• no explicit target variable<ul style="list-style-type: none">• more information• missing information• assumptions needed	<p>Given the number of decisions that need to be made and the missing information that needs to be supplied, this would make a good group test problem. It is probably too "difficult" for a group practice problem (i.e., it would take students more than 25 minutes to discuss and solve) . It would make a very difficult individual test problem.</p>
--	---	--

Activity #11a (Optional): Judging More Group Problems

If you have time, type the context-rich problems the TAs designed and have them judge each problem using the same criteria. Then assign one problem to a group (a different problem than the one they designed), and have them edit and rewrite the problem so it is either a good group practice problem or a good group test problem. Model the process for one problem before they begin.



What Characteristics of Textbook Exercises Promote the Plug-and-Chug Strategy?

Cart A, which is moving with a constant velocity of 3 m/s, has an inelastic collision with cart B, which is initially at rest as shown in Figure 8.3. After the collision, the carts move together up an inclined plane. Neglecting friction, determine the vertical height h of the carts before they reverse direction.

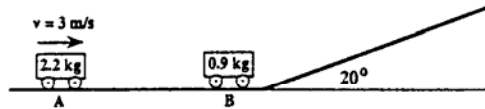

Figure 8.3

Notes: _____



Appropriate Tasks

The problems must be challenging enough so there is a *real* advantage to working in a group.

1. The problem must be complex enough so even the best student in the group can not solve the problem quickly.

The problem must be simple enough so that the solution, once arrived at, can be understood and appreciated.



Appropriate Tasks



2. The problem must be designed so that

- there is something to discuss initially that *everyone* can contribute to (e.g., the problem is difficult to visualize);
- there are several decisions to make in solving the problem (e.g., several different variables that could be calculated to answer the question; several ways to approach the problem);
- the problem cannot be solved in a few steps by plugging numbers into formulas.





Why is This a Better Group Problem?

You are helping your friend prepare for her next skateboard exhibition. For her program, she plans to take a running start and then jump onto her heavy duty 15-lb stationary skateboard. She and the skateboard will glide in a straight line along a short, level section of track, then up a sloped concrete wall. She wants to reach a height of at least 10 feet above where she started before she turns to come back down the slope. She has measured her maximum running speed to safely jump on the skateboard at 7 feet/second. She knows you have taken physics, so she wants you to determine if she can carry out her program as planned. She tells you that she weighs 100 lbs.

Notes: _____

Context-rich Problems

1. Each problem is a short story in which the major character is the student. That is, each problem statement uses the personal pronoun "you."
2. The problem statement includes a plausible motivation or reason for "you" to calculate something.
3. The objects in the problems are real (or can be imagined) -- the idealization process occurs explicitly.
4. No pictures or diagrams are given with the problems. Students must visualize the situation by using their own experiences.
5. The problem can not be solved in one step by plugging numbers into a formula.

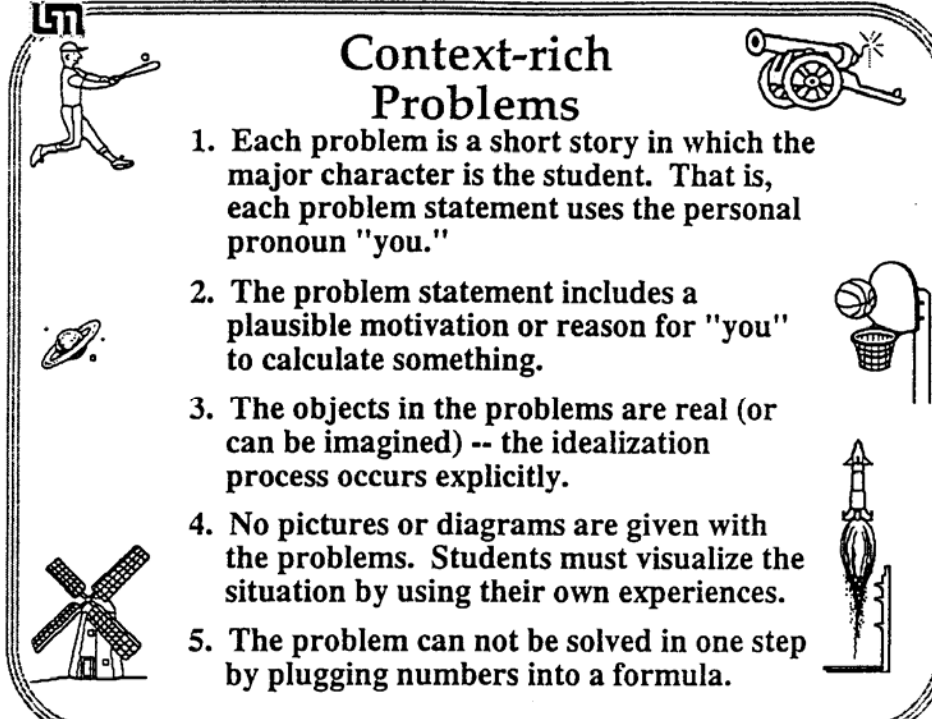

Context-rich Problems

In addition, more difficult context-rich problems can have one or more of the following characteristics:

- The unknown variable is not explicitly specified in the problem statement (e.g., Will this design work?).
- More information may be given in the problem statement than is required to solve the problems, or relevant information may be missing.
- Assumptions may need to be made to solve the problem.
- The problem may require more than one fundamental principle for a solution (e.g., Newton's Laws of Motion and the Conservation of Energy).
- The context can be very unfamiliar (i.e., involve the interactions in the nucleus of atoms, quarks, quasars, etc.)



Why is this not a context-rich problem?

A 44-kg mass is suspended by two ropes, as shown in Figure 4-3. Find the tension in each rope.

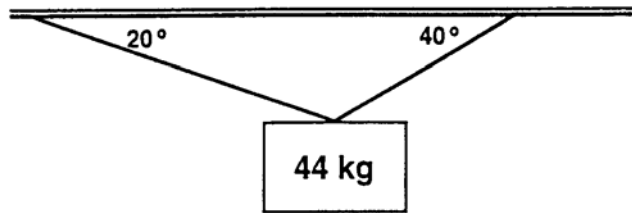

Figure 4-3

Which of the five characteristics of context-rich problems are missing?



Why is this not a context-rich problem?

If an aircraft is properly banked during a turn in level flight at constant speed, the force F_a exerted by the air on the aircraft is directed perpendicular to a plane which contains the aircraft's wings and fuselage (Fig. 6-25). Draw a free-body diagram for such an aircraft. (*Hint: Note the similarity to the conical pendulum in Example 6-7.*) An aircraft traveling at a speed $v = 75 \text{ m/s}$ makes a properly banked turn at a banking angle of 28° . What is the radius of curvature of the turn?

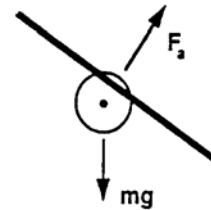

Figure 6-25

Which of the five characteristics of context-rich problems are missing?



Airplane Problem

You are flying into Chicago when the pilot tells you that the plane cannot land immediately because of airport delays, and will have to circle the airport. This is standard operating procedure. She also tells you that the plane will maintain a speed of 400 mph at an altitude of 20,000 feet while traveling in a horizontal circle around the airport. To pass the time, you decide to figure out how far you are from the airport. You notice that to circle, the pilot "banks" the plane so that the wings are oriented about 10° to the horizontal. An article in your in-flight magazine explains that an airplane can fly because the air exerts a force, called "lift," on the wings. The lift is always perpendicular to the wing surface. The magazine article gives the weight of the type of plane you are on as 100×10^3 pounds and the length of each wing as 150 feet. It gives no information on the thrust from the engines or the drag on the airframe.

Which of the additional characteristics of context-rich problems are present?



Why is this not a context-rich problem?

As you are driving to school one day, you pass a construction site for a new building and stop to watch for a few minutes. A crane is lifting a batch of bricks on a pallet to an upper floor of the building. Suddenly a brick falls off the rising pallet. You clock the time it takes for the brick to hit the ground at 2.5 seconds. The crane, fortunately, has height markings and you see the brick fell off the pallet at a height of 72 feet above the ground. Your friend in the car with you asks, "I wonder how fast the pallet was rising before the brick fell off?" Since you are taking physics, you quickly calculate the answer for him.

Which of the five characteristics of context-rich problems are missing?

Designing a Group Problem

GROUP TASKS:

16. Individually read through the following three pages which describe (a) the twenty-one characteristics that make a problem more difficult, and (b) how to create a good group problem.
17. Use these criteria to design a group problem from the standard textbook problem assigned to your group.
18. Write your group problem on the large white sheets.

COOPERATIVE GROUP ROLES:

Skeptic: Ask what other possible contexts or motivations there are for the problem; keep the group from creating a problem that is too easy or too difficult (refer to *What Are the Characteristics of a Good Group Problem?*); agree when satisfied that the group has explored all possibilities.

Manager: suggest a plan for designing a problem (refer to *How to Design a Good Group Problem*); make sure everyone participates and stays on task; watch the time.

Checker/Recorder: ask others to explain their reasoning process so it is clear to all that their suggestions can be discussed; paraphrase, write down, and edit your group's problem.

TIME: 45 minutes.

PRODUCT:

Tape your (signed) group problem to the wall.

What Are The Characteristics of a Good Group Problem?

Group problems should be designed to encourage students to use an organized, logical problem-solving strategy instead of their novice, formula-driven, "plug-and-chug" strategy. Specifically, they should encourage students to (a) consider physics concepts in the context of real objects in the real world; (b) view problem-solving as a series of decisions; and (c) use their conceptual understanding of the fundamental concepts of physics to qualitatively analyze a problem *before* the mathematical manipulation of formulas.

Group problems should be more difficult to solve than easy problems typically given on an individual test. But the increased difficulty should be primarily conceptual, not mathematical. Difficult mathematics is best accomplished by individuals, not by groups. So problems that involve long, tedious mathematics but little physics, or problems that require the use of a shortcut or "trick" that only experts would be likely to know do not make good group problems. In fact, the best group problems involve the straight-forward application of the fundamental principles (e.g., the definition of velocity and acceleration, the independence of motion in the vertical and horizontal directions) rather than the repeated use of derived formulas (e.g., $v_f^2 - v_o^2 = 2ad$).

There are twenty-one characteristics of a problem that can make it more difficult to solve than a standard textbook exercise:

Approach

1 Cues Lacking

- A. No explicit target variable. The unknown variable of the problem is not explicitly stated.
- B. Unfamiliar context. The context of the problem is very unfamiliar to the students (e.g., cosmology, molecules).

2 Agility with Principles

- A. Choice of useful principles. The problem has more than one possible set of useful concepts that could be applied for a correct solution.
- B. Two general principles. The correct solution requires students to use two major principles (e.g., torque and linear kinematics).
- C. Very abstract principles. The central concept in the problem is an abstraction of another abstract concept. (e.g., potential, magnetic flux).

3 Non-standard Application

- A. Atypical situation. The setting, constraints, or complexity is unusual compared with textbook problems.
- B. Unusual target variable. The problem involves an atypical target variable when compared with homework problems.

Analysis of Problem

4 Excess or Missing Information

- A. Excess numerical data. The problem statement includes more data than is needed to solve the problem.
- B. Numbers must be supplied. The problem requires students to either remember or estimate a number for an unknown variable.
- C. Simplifying assumptions. The problem requires students to generate a simplifying assumption to eliminate an unknown variable.

5 Seemingly Missing Information

- A. Vague statement. The problem statement introduces a vague, new mathematical statement.
- B. Special conditions or constraints. The problem requires students to generate information from their analysis of the conditions or constraints.
- C. Diagrams. The problem requires students to extract information from a spatial diagram.

6 Additional Complexity

- A. More than two subparts. The problem solution requires students decompose the problem into more than two subparts.
- B. Five or more terms per equation. The problem involves five or more terms in a principle equation (e.g., three or more forces acting along one axes on a single object).
- C. Two directions (vector components). The problem requires students to treat principles (e.g., forces, momentum) as vectors.

Mathematical Solution

7 Algebra Required

- A. No numbers. The problem statement does not use any numbers.
- B. Unknown(s) cancel. Problems in which an unknown variable, such as a mass, ultimately factors out of the final solution.
- C. Simultaneous equations. A problem that requires simultaneous equations for a solution.

8 Targets Math Difficulties

- A. Calculus or vector algebra. The solution requires the students to sophisticated vector algebra, such as cross products, or calculus.
- B. Lengthy or Detailed Algebra. A successful solution to the problem is not possible without working through lengthy or detailed algebra (e.g., a messy quadratic equation).

BEWARE! Good group problems are difficult to construct because they can easily be made too complex and difficult to solve. A good group problem does not have **all** of the above difficulty characteristics, but usually only 2- 5 of these characteristics.

How to Create Context-rich Group Problems

One way to invent group problems is to start with a textbook exercise or problem, then modify the problem. You may find the following steps helpful:

1. If necessary, determine a context (real objects with real motions or interactions) for the textbook exercise or problem. You may want to use an unfamiliar context for a **very** difficult group problem.
2. Decide on a motivation -- Why would anyone want to calculate something in this context?
3. Determine if you need to change the target variable to
 - (a) make the problem more than a one-step exercise, or
 - (b) make the target variable fit your motivation.
5. Determine if you need to change the given information (or target variable) to make the problem an application of fundamental principles (e.g., the definition of velocity or acceleration) rather than a problem needing the application of many derived formulas.
4. Write the problem like a short story.
5. Decide how many "difficulty" characteristics (characteristics that make the problem more difficult) you want to include, then choose among the following:
 - (a) think of an unfamiliar context; or use an atypical setting or target variable;
 - (b) think of different information that could be given, so two approaches (e.g., kinematics *and* forces) would be needed to solve the problem instead of one approach (e.g., forces), or so that more than one approach could be taken
 - (c) write the problem so the target variable is not explicitly stated;
 - (d) determine extra information that someone in the situation would be likely to have; or leave out common-knowledge information (e.g., the boiling temperature of water);
 - (e) depending on the context, leave out the explicit statement of some of the problem idealizations (e.g., change "massless rope" to "very light rope"); or remove some information that students could extract from an analysis of the situation;
 - (f) take the numbers out of the problem and use variable names only;
- (g) think of different information that could be given, so the problem solution requires the use of vector components, geometry/trigonometry to eliminate an unknown, or calculus.
6. Check the problem to make sure it is solvable, the physics is straight-forward, and the mathematics is reasonable.

Some common contexts include:

- physical work (pushing, pulling, lifting objects vertically, horizontally, or up ramps)
- suspending objects, falling objects
- sports situations (falling, jumping, running, throwing, etc. while diving, bowling, playing golf, tennis, football, baseball, etc.)
- situations involving the motion of bicycles, cars, boats, trucks, planes, etc.
- astronomical situations (motion of satellites, planets)
- heating and cooling of objects (cooking, freezing, burning, etc.)

Sometimes it is difficult to think of a motivation. We have used the following motivations:

- You are (in some everyday situation) and need to figure out
- You are watching (an everyday situation) and wonder
- You are on vacation and observe/notice and wonder
- You are watching TV or reading an article about and wonder
- Because of your knowledge of physics, your friend asks you to help him/her
- You are writing a science-fiction or adventure story for your English class about and need to figure out
- Because of your interest in the environment and your knowledge of physics, you are a member of a Citizen's Committee (or Concern Group) investigating
- You have a summer job with a company that Because of your knowledge of physics, your boss asks you to
- You have been hired by a College research group that is investigating Your job is to determine
- You have been hired as a technical advisor for a TV (or movie) production to make sure the science is correct. In the script, but is this correct?
- When really desperate, you can use the motivation of an artist friend designing a kinetic sculpture!

Textbook Problems

1. Locusts have been observed to jump distances of up to 80 cm on a level floor. Photographs of their jump show that they usually take off at an angle of about 55° from the horizontal. Calculate the initial velocity of a locust making a jump of 80 cm with a takeoff angle of 55° . (Jones & Childers, 1990, p. 84, prob. 3.33)
2. A stone is dropped from rest from a height of 20 m. At the same time, a stone is thrown upward from the ground with a speed of 17 m/s. At what height do their paths intersect? (Jones & Childers, 1993, p. 54, Problem 2.62)
3. (a) What is the minimum time in which one can hoist a 1.00-kg rock a height of 10.0 m if the string used to pull the rock up has a breaking strength of 10.8 N? Assume the rock to be initially at rest. (b) If the string is replaced by one that is 50% stronger, by what percentage will the minimum time for the hoist be reduced? (Jones & Childers, 1993, p. 126, Problem 4.60)
4. What minimum force is required to drag a carton of books across the floor if the force is applied at an angle of 45° to the horizontal? Take the mass of the carton as 40 kg and the coefficient of friction as 0.60. (Jones & Childers, 1993, p. 126, Problem 4.61)
5. A 500-kg trailer being pulled behind a car is subject to a 100-N retarding force due to friction. What force must the car exert on the trailer if (a) the trailer is to move forward at a constant speed of 25 km/hr; (b) the trailer is to move forward with an acceleration of 2.0 m/s^2 ; (c) starting from rest, the trailer and car are to travel 150 m in 10 s? (Jones & Childers, 1993, p. 126, Problem 4.59)
6. A 40-kg child sits in a swing suspended with 2.5-m long ropes. The swing is held aside so that the ropes make an angle of 15° with the vertical. Use conservation of energy to determine the speed the child will have at the bottom of the arc when she is let go. (Jones & Childers, 1993, p. 184, Problem 6.48)
7. An automobile having a mass of 1900 kg and traveling at a speed of 30 m/s is braked smoothly to a stop without skidding in 15 s. (a) How much energy is dissipated in the brakes? (b) What is the average power delivered to the brakes during stopping? (c) If the total heat capacity of the braking system (shoes, drums, etc.) is $.75 \text{ kcal}/^\circ\text{C}$, what is the temperature rise of the brakes during the stop? (Jones & Childers, 1993, p. 323, Problem 11.63)
8. A beam of 10 keV electrons is shot between two parallel plates toward the screen of a cathode ray tube. If the plates are separated by 0.2 mm, have a length of 5 cm and have a separation distance of 16 cm between the screen and the front of the plates, determine the plate potential needed to produce a deflection of 5 cm up the screen.

9. Determine if any of the circuit breakers will be tripped for the following three household circuits. The power rating of each element is given for a 120 Volt source.
- (a) A 20-amp circuit breaker with a 2000 Watt microwave oven and four 100 Watt light bulbs.
 - (b) A 15-amp circuit breaker with a 1500 Watt refrigerator and two 100 Watt light bulbs.
 - (c) A 15 amp circuit breaker with a 200 Watt television, a 500 Watt computer, a 500 Watt vacuum cleaner, and four 60 Watt light bulbs.

NOTES:

Teaching Cooperative-group Problem Solving

Related Readings -- Articles

- Heller, P., Keith, R., and Anderson, S. (1992). Teaching problem solving through cooperative grouping. Part 1: Group versus individual problem solving. *American Journal of Physics*, **60**, 627-636.
- Heller, P., Hollabaugh, M. (1992). Teaching problem solving through cooperative grouping. Part 2: Designing problems and structuring groups. *American Journal of Physics*, **60**, 637-644.
- Smith, K., Johnson, D. and Johnson, R. Cooperation in the College Classroom. Handout. University of Minnesota. pages 2-6 and 14-16.

Related Readings -- Instructor's Manual

The following readings from the Instructor's Manual are included in this booklet:

- Frequently Asked Questions About Cooperative-group Problem Solving (pages 167-169)
- Detailed Advice for Teaching the Lab Sessions (pages 149-153)
- Detailed Advice for Teaching the Discussion Sessions (pages 171 - 174)

Activities

- Activity #12: Typical Objections to Cooperative Group Problem Solving (pages 241- 244)
- Activity #13: What Do You Do Next? Intervening in Groups (pages -)

Instructor's Notes for Teaching the Discussion Sections (about 2 hours)

Activity #12: Typical Objections to Cooperative-Group Problem Solving

Activity #13: What Do You Do Next? Intervening in Groups

The purposes of these activities are to: (1) dispel some of the lingering doubts and misconceptions TAs have about the advantages of cooperative-group problem solving, (2) have TAs realize that they **can** and **should**, at times, intervene in a group to help it function better, and (3) give the TAs a few "one-liner" responses (rationales) for students in some typical situations.

Activity #12: Typical Objections to Cooperative-Group Problem Solving (about 0.5 hours)

We tried having the TAs think about the advantages and disadvantages of cooperative-group problem solving compared to traditional recitation sections. We found, however, that the disadvantages of cooperative-groups the TAs come up with are also disadvantages of traditional sections, but they do not realize this. With a new technique like cooperative groups, there is a tendency to focus on the few students in the class who may not like the technique or may not be learning. We tend to forget that when we show or tell a class something, not everyone is listening, and of those who are listening, not everyone is understanding.

The purpose of this activity is to dispel some of the lingering doubts and misconceptions TAs have about the advantages of cooperative-group problem solving. As a change of pace, you can do this as a whole-group activity.

- a) Motivation: "You have been reading about and we have just discussed some of the reasons we decided to use cooperative-group problem solving at the Univ. of Mn. When we learn a new teaching technique, there is a tendency to focus on the disadvantages of the new technique -- we forget that all techniques, including the traditional techniques with which we are comfortable, have disadvantages. In this activity, you will have an opportunity to compare some common objections to cooperative-group problem solving with the analogous objections to traditional recitation sections."
- b) First have TAs brainstorm some of the characteristics of "traditional" recitation section (on board or a blank overhead) to "get the picture."
- c) Activity: On overhead or board, show and model by thinking out loud the analogous objections to #1 and #5 (see page 238). Then have TAs turn to page 239 and try to do #7 together as a whole class (don't accept ideas that are not analogous objections).

Turn to page 237 -- explain task, have students rotate roles and start.

As groups start working, give each group a blank overhead of one (or two) objection(s) to complete.

- d) Closure: Call on groups to present analogous objections -- get other possible analogous objections from other groups. (If short on time, be sure to do #3, #8, and #9.)
- e) If there is time, have TAs brainstorm other possible objections to cooperative group problem solving.

"The major point is that you can't reach all of the students all of the time, regardless of the instructional technique. The research indicates that cooperative groups have the advantage of reaching more of the students more of the time than traditional lecture methods."

Answer Key:

1. Instructors can not get inside students' minds to see if they are forming alternative conceptions.
2. Some students already know how to solve the problem that is being done on the board, so there is a lot of wasted time.
3. Some students do not ask questions, have not prepared, or are not thinking about the material.
4. You are only answering one student's question, so you don't address the concerns of the other students in the class.
5. The amount covered depends only on how fast the instructor can speak or write. It does not require real time intellectual engagement of the students.
6. Traditionally the weaker students get left behind and the best students are bored.
7. The research indicates that traditional instruction tends to only teach to about the top 15% - 20% of the class. See Claim #7 in Wandersee et. al., 1994 in the reading packet.
8. Lecturing is not teaching because you are concentrating on what **you** say and do instead of concentrating on what your students think.

Recitations are egotistical and authoritarian (i.e., teacher-centered) by nature.
9. Traditional recitations are authoritarian because everyone must interact only with the instructor and must think like them to follow their solutions.
10. Students are bored by being forced to play the role of listener.
11. Students do not want to go to a recitation section which rarely addresses their problem in understanding the concepts. Questions of other students are either so "advanced" that they can't follow or so "simple" that they are bored.

Activity #13: What Do You Do Next? Intervening in Groups (about 1 hour)

Most new TAs are very reluctant to intervene with groups to help them function better. They seem to be unsure of their authority in a classroom. Moreover, they are not very confident or adept at communicating to students the purpose or rationale for the cooperative-group structure of the labs and discussion sessions. The major purposes of this activity are to (1) have TAs realize that they **can** and **should**, at times, intervene in a group to help it function better, and (2) give the TAs a few "one-liner" responses (rationales) for students in some typical situations.

There are many ways this activity could be structured. One possibility is to have the TAs individually respond to each situation on the Activity Sheet (see pages 242-244). As each is completed, they can be discussed. Another possibility is to have three experienced TAs briefly role-play some of the situations. The new TAs are asked first, "What happened? What did you see?" then "What would you do/say next?" After reflecting individually what they would do next, an experienced TA demonstrates one possible response. This response is discussed, along with other possibilities. This process is repeated for as many situations as seem reasonable.

Below are plans for a third, shortened version of the activity:

- a) Motivation: In both the lab and discussion sessions you will teach, you need to monitor groups and intervene when necessary. In this activity, you will be presented with typical cases and asked "What would you do next?"
- b) Activity: Have TAs turn to page 241. Explain task briefly.

After groups start working, pass out overheads with assigned situations.

- c) Closure: Have one member from each group come up and present their group's scenario of what they would do next.

"The major point is that there is no 'one right answer' in the way to intervene or respond. So much depends on the context of the situation, your personality, and the students' personalities."

Typical Objections to Cooperative Group Discussion Sections

When we learn a new teaching technique, there is a tendency to focus on the disadvantages of the new technique -- we forget that **all** techniques, including the traditional techniques with which we are comfortable, have disadvantages. In this activity, you will compare the advantages and disadvantages of cooperative-group discussion sections and traditional recitation sections.

GROUP TASKS:

1. *Individually* read through the eleven typical objections to cooperative-group discussion sections and the possible replies on the attached sheets. Try to think of a parallel or analogous objection to the traditional recitation section (instructor solves assigned homework problems on the board).
2. In your group, first write an analogous objection to the traditional recitation section for the "Typical Objections to Cooperative-group Discussion Sections" assigned to your group.
3. Then discuss in your group the remaining analogous objections.

COOPERATIVE GROUP ROLES:

Skeptic: Ask what other possibilities there are, keep the group from superficial analogies by not allowing the group to agree too quickly; ask questions that lead to a deeper analysis of the objections; agree when satisfied that the group has explored all possibilities.

Manager: Suggest a plan for creating the analogous objections; make sure everyone participates and stays on task; watch the time.

Checker/Recorder: Ask others to explain their reasoning process so it is clear to all that their suggestions can be discussed; paraphrase, write down, and edit your group's analogous objections to the traditional recitation sections.

TIME: 30 minutes.

One member from your group will be randomly selected to present the analogous objections assigned to your group.

PRODUCT:

Overhead of analogous objections.

Typical "Objections" to Cooperative Group Discussion Sections	How Would You Reply?	Analogous Objection in Traditional Recitations
#1. Instructors cannot always be there to stop alternative conceptions from being reinforced in a group.	<p>There is actually less chance of alternative conceptions being maintained in groups because of the interaction between students.</p> <p>The instructor can usually observe the evidence of alternative conceptions by listening to the group discussion or looking at their group solution as it is being constructed.</p>	<i>Instructors cannot get inside students' minds to see if they are forming alternative conceptions.</i>
#2 . Some groups get done before others, so there is a lot of wasted time.	Yes, so be prepared with something for them to do -- either an extension to the problem or have them go to the board and start their solutions.	<i>There is a lot of wasted time because some students</i>
#3. Some students do not contribute -- they "hitch hike" their way through the problem.	This is a sign of a dysfunctional group. You need to intervene.	<i>Some students do not</i>
#4. There is no time to answer student questions about the homework or the lecture.	There are other times available for this -- office hours, review sessions, maybe even during the lab session.	<i>There is no time to</i>

<p>#5. It takes more time to teach with cooperative groups, so less material can be covered.</p>	<p>True. The intention is to teach better a firm understanding of the fundamental concepts upon which to build later applications.</p>	<p><i>The amount covered depends only on how fast the instructor can speak or write. It does not require real-time intellectual engagement of the students.</i></p>
--	--	---

Typical "Objections" to Cooperative Group Discussion Sections	How Would You Reply?	Analogous Objection in Traditional Recitations
#6. Cooperative groups hold back the best students, and the weaker students can "freeload."	Physics education research indicates that cooperative groups seem to help all students because the best students get to "teach" and the weaker students get peer coaching. See Heller, Keith and Anderson (1992) in the reading packet.	<i>The research indicates that with traditional instruction</i>
#7. Often groups are dysfunctional.	Most groups function reasonably well from the outset, although careful intervention and group processing will make them function better. For the approx. 20% of groups that are dysfunctional, you should intervene. No instructional method will reach all students.	<i>Hint: See Claim #7 in Wandersee et.al. in reading packet.</i>
#8. Cooperative grouping is not teaching because anyone can do it. You just stand around and watch.	Observing cooperative groups working allows you to diagnose how the students are thinking, and coach them to overcome their conceptual difficulty (when the other students in the group can not). Cooperative groups are egalitarian and respectful (i.e., student-centered) by nature.	<i>Lecturing is not teaching because</i> <i>Recitations are egotistical and authoritarian (e.g., teacher-centered) by nature.</i>

<p>#9. Cooperative group work is authoritarian because it forces everyone to work together even if they don't like to.</p>	<p>Cooperative groups respect the different ways that students think. They allow students the opportunity of validating their thought process or getting the precise instruction they need.</p>	<p><i>Traditional recitations are authoritarian because</i></p>
--	---	---

Typical "Objections" to Cooperative Group Discussion Sections	How Would You Reply?	Analogous Objection in Traditional Recitations
#10. Students hate to play group roles.	<p>In effective groups, the roles occur naturally and shift among the students. Role playing is a technique to get dysfunctional groups working together. Roles help students who have not learned to work together in teams develop that capability.</p> <p>Be patient. The roles do work, but for some students, it takes time for them to sink in.</p>	<p><i>Hint: What "role" are students forced to play in traditional recitation sections?</i></p>

<p>#11. Students do not want to work in groups because they believe that they learn better on their own.</p>	<p>Learning is a complicated process. To learn something correctly, it is usually necessary for most people to "bounce" their ideas off someone else. For most students, learning is a combination of individual reflection and group interaction. After they get used to it, most students prefer to work in groups. Unfortunately, many students have not developed the simple skills necessary for really effective group work. Practice, especially with roles, will hone these skills.</p> <p>Empathize with those that are uncomfortable, but keep them working in groups. Teamwork is a powerful learning tool and a necessary component for succeeding in the modern world.</p>	<p><i>Students do not want to attend traditional recitation sections because</i></p>
--	---	--

What Do You Do Next? Intervening in Groups

In this activity, you will learn when and how it is appropriate to intervene in groups.

GROUP TASKS:

1. *Individually* read through the seven situations on the attached sheets. Try to think of what you would say/do next (and why) for each situation.
2. With your group, first write some possible responses to the situation(s) assigned to your group -- what would you say/do next?
3. Then discuss with your group possible responses to the remaining situations.

COOPERATIVE GROUP ROLES:

Skeptic: Ask what other possibilities there are, keep the group from superficial responses by not allowing the group to agree too quickly; ask questions that lead to a deeper analysis of the situations; agree when satisfied that the group has explored all possibilities.

Manager: Suggest a plan for generating possible responses to the situations; make sure everyone participates and stays on task; watch the time.

Checker/Recorder: Ask others to explain their reasoning process so it is clear to all that their suggestions can be discussed; paraphrase, write down, and edit your group's possible next actions.

TIME: 30 minutes.

One member from your group will be randomly selected to present your group's decision about what you would say/do next for the situation(s) assigned to your group.

PRODUCT:

Answer Sheet for Activity #13.

What Do You Do Next? Intervening in Groups

What you see and/or hear	What do you say/do next?
<p>#1: Your class has been working on a group problem for about 15 minutes when you notice that one of your groups seems to have split up. Bill and Bob are sitting with their chairs together and talking to each other. The group problem is in front of them, and Bill is recording their progress on the answer sheet. Martha, the third group member, is sitting a little distance away from them, bent over her own paper and working on the problem by herself. You also notice that Bill and Bob are wearing T-shirts from the same fraternity.</p>	
<p>#2: As soon as you pass out the group problem for the day, you notice that one of your groups is unusually quiet. You leave them alone for a while so that they can read the problem. After about five minutes, all the other groups have finished reading the problem and are starting to talk about it. The group that you noticed earlier, however, is still quiet and each person is writing on their own paper. You go over and ask them why they are not talking to each other, and one of them says: "None of us like working in groups, so we decided we'd work alone on the problem."</p>	
<p>#3: You have just assigned students to new groups and as soon as the class gets going, one of your students comes to you and says: "You've got to get me out of this group! I just can't work with Charlie. He drives me crazy with his annoying wisecracks."</p>	
<p>#4: One of your students, Henry, has been late to class for the last three sessions. He never offers you an excuse or talks to you at all. One day, ten minutes before the end of your lab session, you notice that he is gone -- he has left early.</p>	

What you see and/or hear	What do you say/do next?
<p>#5: In your discussion session, the problem for the week is essentially the Modified Atwood Machine. Walking by one group, you see that they are still drawing force diagrams and you stop to listen. One of the group members is someone you usually notice because he has a strong personality and usually gets good grades. When you listen closely you hear that he is stating quite confidently that the normal force of the ramp on the block is equal to the weight of the block. You also notice that the other group members are listening to him, and the recorder/checker is writing this down.</p>	
<p>#6: You are teaching lab and students are taking data to see if the mass of an object in free fall affects its acceleration. One group seems not to be as far along in the lab as the other groups. You decide to keep an eye on them to see why. Watching them closely, you notice that one person in the group has all the contact with lab equipment. First everyone in the group watches him make a spark tape, then everyone goes to the triple-beam balance to watch him mass their object, then everyone watches him measure the spark tape.</p>	
<p>#7: It's partway through the semester, and you have just returned the graded lab reports on two-dimensional motion to your lab section as your students start work on the Forces Lab. After a few minutes, one student leaves her group, comes up to you, and asks you why the acceleration of a ball thrown up in the air is not zero at the top.</p>	

TA Orientation 1999
Activity #13 Answer Sheet (2 points)

Manager: _____
Recorder: _____
Skeptic: _____
Skeptic: _____

Answer Sheet

Situation # ____:

Situation # ____:

Professionalism and Establishing a Positive Classroom Climate

Related Readings

Equal Opportunity and Affirmative Action at the University of Minnesota (1999). University of Minnesota.

Shymansky, J.A. and Penick, J.E. (1979). Do laboratory teaching assistants exhibit sex bias? *Journal of College Science Teaching*, **8**, 223-225.

Seymour, E. (1992). Undergraduate problems with teaching and advising in SME majors - explaining gender differences in attrition rates. *Journal of College Science Teaching*, **21**, 284-292.

Standards of Student Conduct Enforceable by University Agencies (1993). Booklet, University of Minnesota.

Activities

We spend approximately three hours on issues related to professionalism and establishing and maintaining a positive classroom climate. To help TAs feel comfortable discussing these issues, the mentor TAs lead the discussion and there are no faculty present for this day. TAs have read the above articles and University of Minnesota booklets before they complete the following activities:

1. Establishing a Positive Classroom Climate and Cheating (page 251)
Activity #15: Scholastic Dishonesty is . . . (pages 253 - 256)
2. Maintaining a Positive Classroom and Department Climate (page 259)
Activity #16: Case Studies: Diversity and Gender Issues (pages 261 - 271)

**Instructor's Notes for
Establishing a Positive Classroom Setting and Cheating
(about 1 hour)**

Part a: Setting the climate discussion:

- 1) Motivation/Introduction: "You will be asked by your professor to proctor and grade exams. You will also need to proctor your students when they work on group quizzes in your discussion sections. In each of these settings you will need to establish a positive classroom climate, which includes preventing cheating.

You are in a difficult and new situation as TAs. You are both a graduate student and a teacher. You need to be aware that you are an agent of the University when you are acting as a TA, and responsible for enforcing university policy. However, you are also subject to these same regulations as a graduate student. As a graduate student, you will find it easy to empathize with your students, but you cannot forget that you are foremost their teacher.

You can help yourself as a TA by establishing a "positive classroom climate."

- 2) Show the first overhead (see page 253) and introduce the term Classroom Climate and why it is important.
- 3) Divide the room in half. Let half the groups brainstorm factors that contribute to a positive classroom climate. The other half of the groups will brainstorm factors that contribute to a negative classroom climate. (Give them about 4 minutes.)
- 4) For the next five minutes, collect positive and negative factors from the groups, and write on an overhead. Be aware that the converse of most positive factors could be considered negative, and vice-versa.
- 5) Transition: "In spite of our best efforts, problems will occur. That is why we are spending this morning on how to maintain a positive classroom climate. We will first consider how to avoid cheating on tests, then look at diversity — cultural and gender issues."

Part b: Activity #15: Scholastic dishonesty is...

- 1) Distribute the T/F questionnaires (see page 254). The TAs were required to read the University's Academic misconduct policy for homework. Give them about 4 minutes to complete. (Note: First impressions are all that is needed.)
- 2) "Any false answers?" Note that #7 and #10 are ambiguous and would depend on the situation. Question 7 will hopefully come up and allow a transition into c).
- 3) Cheating and Cooperative groups. "When students are working in cooperative groups, the line between collaboration and cheating may appear to be blurred. This does not have to be. If you establish clear *expectations* of product and level of cooperation required, it should be

obvious who is cheating.

For example, if everyone in a group is contributing to the final product, then there is no cheating. If someone is copying the group's data without contributing to its acquisition, then that group is cheating - the whole group, not just the student who is copying.

You need to make your expectations clear to your students from the onset about what you consider to be inappropriate group behavior and what qualifies as cheating."

- 4) Discuss measures to be taken to avoid cheating. "What can we do to prevent cheating? As expert students, you probably have some experience with friends who have cheated. First, think of all the ways you know of people cheating and second, think of how we can prevent it from happening to us." Allow 10-15 minutes.
- 5) Hints for proctoring are included on page 59 in the Instructor's Handbook (see pages 256 - 257 in this booklet). "You should discuss your team's cheating guidelines in your first team meeting."

Classroom Climate

A positive Classroom Climate can play an important role in determining academic misconduct and sexual harrassment.



In your groups:

1. Recall examples of positive/negative classroom climates.
- 2.. Brainstorm factors that contributed to the positive/negative classroom climate

Notes: _____

Scholastic Dishonesty is ...

Directions: Circle **T** if the statement accurately completes the above sentence;
Circle **F** if the statement does not accurately complete the above sentence.

- T / F 1. The act of passing off someone else's work as your own.
- T / F 2. Extensive assistance from other people on an assignment without recognition.
- T / F 3. Using sections of someone else's homework assignment.
- T / F 4. Looking at another student's examination during a testing situation.
- T / F 5. Conferring with fellow students during an examination period.
- T / F 6. Allowing another student to copy from your examination.
- T / F 7. Using notes stored on a calculator during a closed-book examination.
- T / F 8. Using another person's idea without acknowledging that person.
- T / F 9. Allowing another student to copy sections of your paper.
- T / F 10. Signing another student's name on an attendance sheet.
- T / F 11. Permitting another student to sign your name on an attendance sheet.
- T / F 12. Collaborating with a fellow student on a take home exam.
- T / F 13. Copying an answer to a problem line-for-line from a textbook or solution manual without identifying where it came from.
- T / F 14. An act that can result in expulsion from the University.

Adapted with permission from the Teaching Enrichment Program at the University of Minnesota.

LM



Cheating

- As expert students, you probably have some experience with friends who have cheated. First, think of all the ways you know of people cheating.
- Brainstorm how you can prevent it from happening to you.

2

How Students Cheat	How to Prevent

NOTES:

**Instructor's Notes for Classroom and Department Climate:
Diversity and Gender Issues
(about 1.5 - 2 hours)**

Activity #16: Case Studies: Diversity and Gender Issues

We use case studies for students to begin to think about their attitudes and responsibilities with regard to (1) students from diverse cultures, (2) possible sexual harassment, and (3) fellow graduate students in the department.

The case studies (see pages 251 - 261) are in three groups:

Case Studies #1 through #6 describe cultural/gender situations that TAs might encounter in their teaching. The TAs are asked about their responsibilities, what they could do to prevent the situation, and/or what they could do to resolve the situation.

Case Studies #7 and #8 describe encounters between people from the U.S. and international students. The purpose of these case studies is to raise awareness about how cultural differences can influence attitudes and behaviors. The TAs are asked to describe the situation, give causes or an interpretation of the situation, and brainstorm possible solutions.

Case Studies #9 through #11 describe encounters among physics graduate students or between graduate students and professors. The purpose of these case studies is to raise awareness of attitudes and behaviors necessary to create a positive climate within the physics department.

The three sets of case studies could be used in three different activities, or they could be used in one, long activity.

- a) Motivation/Introduction: "In the physics department, we have graduate students from all over the world. To create a positive climate for yourselves in the physics department, it is helpful to be aware of situations that can arise because of cultural differences in expectations and behaviors. You will also teach students of different genders, ethnicities, and exceptionalities. We are going to examine the case studies that you read as part of your homework as a vehicle for discussing our reactions and responsibilities."
- b) Assign one (or more) case study to each group. The group discusses the critical incident and answers the questions. They then decide how they are going to lead a class discussion about the incident.

- c) Closure: Call on each group to lead a class discussion about their case study. You may need to ask questions occasionally (or play devil's advocate) to keep the discussion going or to bring a different viewpoint into the discussion. We have found, however, that our graduate students usually have very lively discussions about the case studies and come up with many alternate solutions.

Case Studies: Diversity and Gender Issues

Group Task:

This exercise uses "critical incidents" derived from encounters among and between teachers and students at the University of Minnesota. The critical incidents are, as the name implies, incidents or situations that are of importance in understanding the behavior, values, and cultural differences of those described in the incident. Case Studies #1 through #6 deal with incidents you might encounter as a graduate teaching assistant. Case Studies #7 and #8 describe encounters between people from the U.S. and international scholars. Case Studies #9 through #11 deal with incidents with fellow graduate students.

The incidents are open-ended, with no absolute right answer to be guessed or learned. In our discussion of the incidents, several explanations, alternatives, or solutions could be proposed depending on the personality, style, or culture of the individuals.

Discuss the four critical incidents assigned to your group. Use the guidelines listed under each critical incident to begin the discussion. There is no need to limit your discussion to just the questions provided.

Group Roles:

Skeptic: Ask what other possibilities there are, keep the group from superficial analysis by not allowing the group to agree too quickly; ask questions that lead to a deeper analysis; agree when satisfied that the group has explored all possibilities.

Manager: Suggest a plan for discussing each incident and answering the questions; make sure everyone participates and stays on task; watch the time.

Checker/Recorder: Ask others to explain their reasoning process so it is clear to all that their suggestions can be discussed; paraphrase, write down, and edit your group's response to each incident.

TIME: 25 minutes

The *Checker/Recorder* will be asked to make the opening comments about **one** of the assigned case studies when we return to the larger group.

Group Product:

Answer Sheets for four assigned Case Studies.

Case Study #1*

One of your physics students is a highly achieving undergraduate who is very bright, personable, and attractive. You enjoy working with this student, but are not otherwise interested in a relationship. Unexpectedly, the student leaves you a note, professing an interest in establishing a close relationship, along with a bouquet of flowers.

*Adapted from University-wide sexual harassment training

1. What are your responsibilities in this situation?
2. How can you maintain the kind of teaching relationship you want?

NOTES:

Case Study #2*

One day, as you are waiting for students to come in and settle down for your discussion session, you notice that one of the students enters wearing a T-shirt which is emblazoned with a sexually obscene and violent slogan. The student sits down as the bell rings for the class to begin. Just as you are about to begin your opening game, another student states loudly that he cannot sit in the class and attempt to learn if that T-shirt is allowed to stay there. The two students then engage in a shouting match.

*Taken from University-wide sexual harassment training

1. What are your responsibilities in this situation?
2. What are some possible solutions?

NOTES:

Case Study #3

You are discussing with your class the physics of sound, specifically why longer musical instruments make deeper sounds. To provide a quick demonstration, you have one male student and then one female student stand up and say "oooh." After the session, the female student goes to the professor and says that she felt singled out since she is the only woman in the class. Further, she was upset and embarrassed since saying "oooh" loudly in a room full of men seemed to her to be too sexual a thing to do.

1. What could you have done to prevent the situation?
2. What could you do to resolve the situation?
3. What could your professor have done to prevent the situation?
4. What could the professor do to resolve the situation?

NOTES:

Case Study #4

Jose, a student in your section, is in a wheelchair. His brother Pedro is in the same section, and is very protective of Jose. (Pedro registered for all the same classes as Jose on purpose so that he can help him out.) The brothers want to be in the same group, but you want to have diverse groups so that students can get to know one another. However, because of Jose's disability you give in to the brothers and put them in a group with two other people. When there is a group test problem, the brothers surprise you by speaking Spanish to one another. You ask them to speak English so that everyone in the group can understand. They tell you that they don't think they read English as well as other people in the class and are just talking to each other in Spanish to be sure that they understand the quiz problem.

1. What could you have done to prevent the situation?
2. What can you do to resolve the situation?

NOTES:

Case Study #5

You are a relaxed TA, often chatting and laughing with students in your section before you start class. One day before lab, you discover that you share an interest in racquetball with one of your students and you make an appointment to play. Soon you are meeting every Wednesday at lunch for a racquetball game with this student and becoming friends. The other students in your section know about this and are upset about it. You think it's no big deal, since it's not as though you are romantically involved with your student.

1. What are your responsibilities in this situation?
2. What can you do to resolve the situation?

NOTES:

Case Study #6

Early in the spring semester, one of your fellow team members stops by your lab section and starts chatting and visiting with one of your students during the lab. It is soon obvious that the two are in a relationship. After lab, you find out that this student was in the TA's lab last term.

1. What are your responsibilities in this situation?
2. What can you do to resolve the situation?

NOTES:

Case Study #7*

Abdelkader, Mohammed and Naji, students from the same country, are close to completing their first semester at the University. When they first met at the new student orientation program and discovered they were all in the same engineering department, they arranged their schedules so they could take most of their classes together. Every day before their physics class they met to study each other's notes and to discuss the assigned reading and homework they had done the night before.

Their physics professor noticed that the three students made nearly the same errors in the first exam of the semester. At the time, he assumed it was because they were from the same educational background. However, when he noticed that all three students had exactly the same problems incorrect on their second test, he decided they had to be cheating. The professor called the students into his office and explained that this type of behavior was unacceptable. He told them that he was going to call the foreign-student advisor to see what action could be taken because of their cheating.

*Adapted from Florence A. Funk's "Intercultural Critical Incidents"

1. What happened? (Describe the situation.)
2. Why? (Give causes/interpretation of the situation.)
3. Alternatives/Solutions:
 - a. What could have been done to prevent the situation?
 - b. What can be done to resolve the situation?

NOTES:

Case Study #8*

Chong, a new international student at the University of Minnesota, arrived on campus two weeks before classes began so he could find housing, register for classes and become familiar with the St. Paul-Minneapolis area. During this two week period everything went well. He found an apartment to share with a U.S. student from his department, was able to register for all the classes he needed, and made the acquaintance of a few other students. Once classes began Chong discovered that he was thrilled with the discussion that took place between the students and professors in his classes, he enjoyed the company of his roommate's friends and he enjoyed the easy access to movies, shopping, and fast food establishments.

About three weeks into the term, Chong began to find the endless classroom discussions a waste of time. He was frustrated with the ridiculous antics of his roommate's friends and it seemed that everything he needed cost too much. He found that he was now seeking the company of his countrymen and that their discussions most often centered on how "screwed-up" everything was in the States. He ate lunch in a local ethnic restaurant and avoided contact with students from the U.S. unless it was required to fulfill classroom assignments.

*Taken from Florence A. Funk's "Intercultural Critical Incidents"

1. What happened? (Describe the situation.)
2. Why? (Give causes/interpretation of the situation.)
3. Alternatives/Solutions:
 - a. What could have been done to prevent the situation?
 - b. What can be done to resolve the situation?

NOTES:

Case Study #9

Boris is a first year physics graduate student from Russia. Although he speaks English with a heavy accent, he is fluent and is given his own discussion and lab sections to teach. After a few weeks he becomes puzzled by his students' behavior. Even though he can tell from their test scores that they are confused about physics, they never ask questions or come to his office hours. They come to class late and have to be asked two or three times before they will respond when he asks them to go to the board. Boris comes to you and asks what he should do.

1. What happened? (Describe the situation.)
2. Why? (Give causes/interpretation of the situation.)
3. Alternatives/Solutions:
 - a. What could have been done to prevent the situation?
 - b. What can you do to help resolve the situation?

NOTES:

Case Study #10

Mary was having some difficulty in one of her 5000-level physics classes. She had trouble with the homework assignments and then scored below the median on the first two exams. About halfway through the term, Mary went to see the professor to ask him for help. He told Mary that she should really be ashamed at her performance in the class and that she would probably fail. He refused to help her and told her that she should drop out of school, since it was unlikely that she would ever be a physicist. After meeting with him, the student was so upset that she went to the top of a tall building and considered killing herself.

1. What happened? (Describe the situation.)
2. Why? (Give causes/interpretation of the situation.)
3. Alternatives/Solutions:
 - a. What could Mary have done to prevent the situation?
 - b. What can Mary do to resolve the situation?
 - c. What could the professor have done to prevent the situation?
 - d. What could you (as one of Mary's classmates) do to prevent or resolve the situation?

NOTES:

Case Study #11

In one of her sections Susan had a male student, Joe, who was very self-assured. During her office hours, he often sat very close to her and put his arm around the back of her chair. One day in lab, as Susan helped a group at the next table, Joe reached behind him and stroked her leg. She said, "Don't do that," and asked to speak to him after class. When the other students had gone, Susan said, "I don't know what you thought you were doing when you touched my leg in class." Joe said that it had been an accident, and Susan ended the conversation. Immediately after that, she went to see the lecturer for Joe's class and told him the whole story. The professor laughed.

1. What happened? (Describe the situation.)
2. Why? (Give causes/interpretation of the situation.)
3. Alternatives/Solutions
 - a. What could the TA (Susan) have done to prevent the situation?
 - b. What could Susan do to resolve the situation?
 - c. What could the professor have done to prevent the situation?
 - d. What could the professor do to resolve the situation?

NOTES:

Proctoring and Record Keeping

1. Proctoring Exams

The purpose of proctoring is to make the students as comfortable as possible in the stressful environment of taking an exam. You can achieve this goal by:

- ♦ being familiar with the test and prepared to be fast, friendly and helpful when students have questions;
- ♦ going over the exam with the professor before it is given to determine what help you may or may not give;
- ♦ announcing to the whole class any answer for an individual student's question that you feel might be generally helpful. It must appear to all students that you are not showing any favoritism;
- ♦ being especially helpful in explaining the meaning of words or situations to foreign students;
- ♦ protecting the students from the small minority of students who try to cheat.

Before the exam starts:

- ♦ TAs given the assignment of proctoring will pick up exams from Room 148, the Undergraduate Offices. Count the number of exams you picked-up and enter the necessary information into the *Proctoring Book*.
- ♦ If the course to be proctored is 1xxx level, the TA must pick up exams 15 minutes before the class begins; 3xxx and 5xxx class exams should be picked up 10 minutes prior to class time. Distribute tests according to the professor's instructions.
- ♦ Also, be sure that you are clear about what the professor wants you to do if you feel that cheating is occurring during the test.

At the start of the exam:

- ♦ Read any special instructions from the professor to the class.
- ♦ Explicitly tell the students what materials they may use and may not use (i.e. calculator, textbooks, etc.). This may mean reading the exam's instructions aloud to the class.
- ♦ Be sure the students are sitting every other seat. Watch for people who insist on sitting diagonally behind someone else.
- ♦ After you are sure all student materials are properly stored, you should pass out the exams as efficiently as possible. You may want to explicitly state where the students can store their backpacks, books, etc...(for example: underneath the chair.)
- ♦ Announce when the exam is scheduled to end.

During the exam:

- ♦ Count the number of students in the room. Check your count with your proctoring partner.

- ◆ Write the time remaining on the board at least every five minutes. Announce when there are 5 minutes left.
- ◆ It is important that you remain active. This will let the students know that you are not too busy to help them and it will discourage cheating. Quietly and unobtrusively, walk around the room watching the students work. Do not just sit in the front of the room.
- ◆ Try to answer a student's question as quickly and as quietly as possible. Try not to disturb the other students. If you get asked the same question more than twice, announce your answer to the class.
- ◆ Today's calculators can store an enormous amount of information and some can exchange information with other calculators over a short distance. Watch for students who are overusing their calculators.
- ◆ If you do suspect that someone is cheating, discretely explain your reasons to your proctoring partner and both of you should watch for the behavior.
- ◆ If you both are reasonably sure that cheating is occurring, carry out the instructions from the professor in charge of the class. (Prior to the exam, ask the professor what he/she wants you to do when cheating occurs.)
- ◆ If you both are not reasonably sure that cheating is occurring, but you still suspect that it might be, you can move the students involved.
- ◆ Do not tell jokes to your proctoring partner. The students might think that you are laughing at them. *Many students have complained about proctors who are laughing during exams.* Remember exams are deadly serious for your students.

At the end of the exam:

- ◆ Watch for students who use the commotion of the end of the exam to cheat.
- ◆ Count the number of exams received and compare it to the number of students at the exam.
- ◆ Check the room for lost items - some of them might be "cheat sheets."

After the exam is complete, bring ALL tests back to Room 148. Count the number of tests again and enter the necessary information into the *Proctoring Book*. Place all extra exams in a separate pile to be picked up by the professor.

2. Grading Exams/Homework

TAs picking up homework problems and exams to grade must count the number of assignments and fill out the necessary information in the *Grader Book* before taking them out of the Physics office. Upon returning the graded exams, they must again be counted and signed back into this book.

Grades should be entered into the appropriate spreadsheet available in room 216. See page 120 for instructions for entering grades into the computers.

Graders must also fill out a *Paper Grading Form* indicating how many hours were necessary to grade that particular assignment. This is an important record that the office needs each time a graded assignment comes in. It is from this information that work load assignments are made.

3. Keeping Lab Scores In the *Class Record Book*

TAs will record lab scores for each lab section they teach. Scores will be kept according to the professor's instructions in a green *Class Record Book*. These books, as well as red pens for grading, can be obtained in Room 148.

IMPORTANT:

These procedures have been used successfully in the Physics Department for years. While some steps may seem insignificant or redundant, they are necessary in safeguarding you and your students' work assignments in case of cheating, loss or error.

Homework #4 (5 points)**Using a Strategy to Solve Context-rich Problems**

Assume that you have been asked by your professor to write the solutions for the five problems on the following pages. Since the solutions will be posted (or photocopied to pass out to your students), your professor asks you to use the problem-solving strategy from *The Competent Problem Solver*. You must use the physics equations shown below each problem, and the mathematical relationships and constants shown at the bottom of this page, because these are the relationships the students were allowed to use at the time the problem was solved in a discussion section or for an individual exam. Of course, the problems may call for other common information that students are expected to know, like the boiling temperature of water or the relationship between density, mass, and volume.

Hint: It may be helpful to browse through the example solutions in *The Competent Problem Solver* and read page 3-2 (motion diagrams), pages 4-2 to 4-7 (free-body and force diagrams), and pages 5-3 to 5-5 (conservation of energy diagrams) to see how the "physics description" step is completed for different kinds of problems.

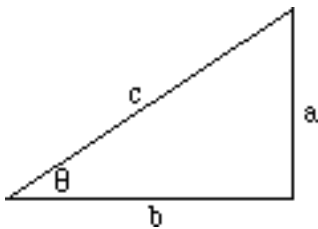
Useful Mathematical Relationships:

For a right triangle: $\sin \theta = \frac{a}{c}$, $\cos \theta = \frac{b}{c}$, $\tan \theta = \frac{a}{b}$,

$$a^2 + b^2 = c^2, \sin^2 \theta + \cos^2 \theta = 1$$

For a circle: $C = 2\pi R$, $A = \pi R^2$

For a sphere: $A = 4\pi R^2$, $V = \frac{4}{3} \pi R^3$

If $Ax^2 + Bx + C = 0$, then $x = \frac{-B \pm \sqrt{B^2 - 4AC}}{2A}$; $\text{ave}(\sin^2 z) = \text{ave}(\cos^2 z) = \frac{1}{2}$

$$\frac{d(z^n)}{dz} = nz^{n-1} , \frac{d(\cos z)}{dz} = -\sin z , \frac{d(\sin z)}{dz} = \cos z , \frac{df(z)}{dt} = \frac{df(z)}{dz} \frac{dz}{dt} , \int \left(\frac{dw}{dz}\right) dz = w ,$$

$$\frac{d}{dz} \int (w) dz = w , \int (z^n) dz = \frac{z^{n+1}}{n+1}$$

Useful constants: $g = 9.8 \text{ m/s}^2 = 32 \text{ ft/s}^2$, $1 \text{ lb} = 4.45 \text{ N}$, $1 \text{ mile} = 5280 \text{ ft}$,
 $1 \text{ gal} = 3.785 \text{ liters}$

Homework #4 (5 points)

1. **Oil Tanker Problem:** Because of your technical background, you have been given a job as a student assistant in a University research laboratory that has been investigating possible accident avoidance systems for oil tankers. Your group is concerned about oil spills in the North Atlantic caused by a super tanker running into an iceberg. The group has been developing a new type of radar which can detect large icebergs. They are concerned about its rather short range of 2 miles. Your research director has told you that the radar signal travels at the speed of light, which is 186,000 miles per second, but once the signal arrives back at the ship it takes the computer 5 minutes to process the signal. Unfortunately, the super tankers are such huge ships that it takes a long time to turn them. Your job is to determine how much time would be available to turn the tanker to avoid a collision once the tanker detects an iceberg. A typical sailing speed for super tankers during the winter on the North Atlantic is about 15 miles per hour. Assume that the tanker is heading directly at an iceberg that is drifting at 5 miles per hour in the same direction that the tanker is going. (Remember you can only use the fundamental concepts listed below.)

Fundamental Concepts: $\vec{v}_{av} = \frac{\Delta \vec{r}}{\Delta t}$

Homework #4 (5 points)

2. **Ice Skating Problem:** You are taking care of two small children, Sarah and Rachel, who are twins. On a nice cold, clear day you decide to take them ice skating on Lake of the Isles. To travel across the frozen lake you have Sarah hold your hand and Rachel's hand. The three of you form a straight line as you skate, and the two children just glide. Sarah must reach up at an angle of 60 degrees to grasp your hand, but she grabs Rachel's hand horizontally. Since the children are twins, they are the same height and the same weight, 50 lbs. To get started you accelerate at 2.0 m/s^2 . You are concerned about the force on the children's arms which might cause shoulder damage. So you calculate the force Sarah exerts on Rachel's arm, and the force you exert on Sarah's other arm. You assume that the frictional forces of the ice surface on the skates are negligible. (Remember you can only use the fundamental concepts listed below.)

Fundamental Concepts: $\bar{v}_{av} = \frac{\Delta \bar{r}}{\Delta t}$, $\bar{a}_{av} = \frac{\Delta \bar{v}}{\Delta t}$, $\bar{v} = \frac{d\bar{r}}{dt}$, $\bar{a} = \frac{d\bar{v}}{dt}$, $\Sigma \bar{F} = m\bar{a}$, $F_{12} = F_{21}$

Under Certain Conditions: $r_f = \frac{1}{2} a_r t^2 + v_{ro} t + r_o$, $F = \mu_{sliding} N$, $F \leq \mu_{static} N$

Homework #4 (5 points)

3. **Safe Ride Problem:** A neighbor's child wants to go to a neighborhood carnival to experience the wild rides. The neighbor is worried about safety because one of the rides looks dangerous. She knows that you have taken physics and so asks your advice. The ride in question has a 10-lb. chair which hangs freely from a 30-ft long chain attached to a pivot on the top of a tall tower. When a child enters the ride, the chain is hanging straight down. The child is then attached to the chair with a seat belt and shoulder harness. When the ride starts up the chain rotates about the tower. Soon the chain reaches its maximum speed and remains rotating at that speed. It rotates about the tower once every 3.0 seconds. When you ask the operator, he says that the ride is perfectly safe. He demonstrates this by sitting in the stationary chair. The chain creaks but holds and he weighs 200 lbs. Has the operator shown that this ride safe for a 50-lb. child? (Remember you can only use the fundamental concepts listed below.)

Fundamental Concepts: $\vec{v}_{av} = \frac{\Delta \vec{r}}{\Delta t}$, $\vec{a}_{av} = \frac{\Delta \vec{v}}{\Delta t}$, $\vec{v} = \frac{d\vec{r}}{dt}$, $\vec{a} = \frac{d\vec{v}}{dt}$, $\Sigma \vec{F} = m\vec{a}$, $F_{12} = F_{21}$

Under Certain Conditions: $r_f = \frac{1}{2} a_f t^2 + v_{ro} t + r_o$, $a = \frac{v^2}{r}$, $F = \mu_{sliding} N$, $F \leq \mu_{static} N$,
 $F = -k_s x$

Homework #4 (5 points)

4. **Cancer Therapy Problem:** You have been able to get a part time job with a medical physics group investigating ways to treat inoperable brain cancer. One form of cancer therapy being studied uses slow neutrons to knock a particle (either a neutron or a proton) out of the nucleus of the atoms which make up cancer cells. The neutron knocks out the particle it collides with in an inelastic collision. The heavy nucleus essentially does not move in the collision. After a single proton or neutron is knocked out of the nucleus, the nucleus decays, killing the cancer cell. To test this idea, your research group decides to measure the change of internal energy of a nitrogen nucleus after a neutron collides with one of the neutrons in its nucleus and knocks it out. In the experiment, one neutron goes into the nucleus with a speed of 2.0×10^7 m/s and you detect two neutrons coming out at angles of 30° and 15° . (Remember you can only use the fundamental concepts listed below.)

Fundamental Concepts:

$$\bar{v}_{av} = \frac{\Delta \bar{r}}{\Delta t}, \quad \bar{a}_{av} = \frac{\Delta \bar{v}}{\Delta t}, \quad \bar{v} = \frac{d\bar{r}}{dt}, \quad \bar{a} = \frac{d\bar{v}}{dt}, \quad \Sigma \bar{F} = m\bar{a}, \quad F_{12} = F_{21},$$

$$\Delta E_{system} = \Delta E_{transfer}, \quad KE = \frac{1}{2}mv^2, \quad E_{transfer} = \int_{r_i}^{r_f} \bar{F} \cdot d\bar{r},$$

$$\Delta \bar{p}_{system} = \Delta \bar{p}_{transfer}, \quad \bar{p} = m\bar{v}, \quad \bar{p}_{transfer} = \int_{t_i}^{t_f} \bar{F} dt$$

Under Certain Conditions:

$$r_f = \frac{1}{2}a_1 t^2 + v_{ro}t + r_o, \quad a = \frac{v^2}{r}, \quad F = \mu_{sliding}N, \quad F \leq \mu_{static}N,$$

$$F = -k_s x, \quad \Delta U = -\int_{r_i}^{r_f} \bar{F} \cdot d\bar{r}.$$

Homework #4 (5 points)

5. **Kool Aid Problem:** You are planning a birthday party for your niece and need to make at least 4 gallons of Kool-Aid, which you would like to cool down to 32 °F (0 °C) before the party begins. Unfortunately, your refrigerator is already so full of treats that you know there will be no room for the Kool-Aid. So, with a sudden flash of insight, you decide to start with 4 gallons of the coldest tap water you can get, which you determine is 50 °F (10 °C), and then cool it down with a 1-quart chunk of ice you already have in your freezer. The owner's manual for your refrigerator states that when the freezer setting is on high, the temperature is -20 °C. Will your plan work? You assume that the density of the Kool-Aid is about the same as the density of water. You look in your physics book and find that the density of water is 1.0 g/cm³, the density of ice is 0.9 g/cm³, the heat capacity of water is 4200 J / (kg °C), the heat capacity of ice is 2100 J / (kg °C), the heat of fusion of water is 3.4 x 10⁵ J/kg, and its heat of vaporization is 2.3 x 10⁶ J/kg. (Remember you can only use the fundamental concepts listed below.)

Fundamental Concepts:

$$\vec{v}_{av} = \frac{\Delta \vec{r}}{\Delta t}, \quad \vec{a}_{av} = \frac{\Delta \vec{v}}{\Delta t}, \quad \vec{v} = \frac{d\vec{r}}{dt}, \quad \vec{a} = \frac{d\vec{v}}{dt}, \quad \Sigma \vec{F} = m\vec{a}, \quad F_{12} = F_{21},$$

$$\Delta E_{system} = \Delta E_{transfer}, \quad KE = \frac{1}{2}mv^2, \quad E_{transfer} = \int_{r_i}^{r_f} \vec{F} \cdot d\vec{r},$$

$$\Delta \vec{p}_{system} = \Delta \vec{p}_{transfer}, \quad \vec{p} = m\vec{v}, \quad \vec{p}_{transfer} = \int_{t_i}^{t_f} \vec{F} dt$$

Under Certain Conditions:

$$r_f = \frac{1}{2}a_1 t^2 + v_{ro}t + r_o, \quad a = \frac{v^2}{r}, \quad F = \mu_{sliding}N, \quad F \leq \mu_{static}N,$$

$$F = -k_s x, \quad \Delta U = -\int_{r_i}^{r_f} \vec{F} \cdot d\vec{r}, \quad \Delta E_{internal} = c m \Delta T, \quad \Delta E_{internal} =$$

m L

Judging Problems

Outlined below is a decision strategy to help you decide whether a context-rich problem is a good individual test problem, group practice problem, or group test problem.

1. *Reject* if:
 - the problem can be solved in one step,
 - the problem involves long, tedious mathematics, but little physics; or
 - the problem can only be solved easily using a "trick" or shortcut that only experts would be likely to know. (In other words, the problem should be a straightforward application of fundamental concepts and principles.)

2. *Check* for the twenty-one characteristics that make a problem more difficult (see Instructor's Handbook for complete definitions).

Approach	Analysis	Mathematical Solution
1. Cues Lacking <input type="checkbox"/> A. No target variable <input type="checkbox"/> B. Unfamiliar context	4. Excess or Missing Info. <input type="checkbox"/> A. Excess data <input type="checkbox"/> B. Numbers required <input type="checkbox"/> C. Assumptions	7. Algebra required <input type="checkbox"/> A. No numbers <input type="checkbox"/> B. Unknown(s) cancel <input type="checkbox"/> C. Simultaneous eqns.
2. Agility with Principles <input type="checkbox"/> A. Choice of principle <input type="checkbox"/> B. Two principles <input type="checkbox"/> C. Abstract principle	5. Seemingly Missing Info. <input type="checkbox"/> A. Vague statement <input type="checkbox"/> B. Special constraints <input type="checkbox"/> C. Diagrams	8. Targets Math Difficulty <input type="checkbox"/> A. Calc/vector algebra <input type="checkbox"/> B. Lengthy algebra
3. Non-Standard Application <input type="checkbox"/> A. Atypical situation <input type="checkbox"/> B. Unusual target	6. Additional Complexity <input type="checkbox"/> A. >2 subparts <input type="checkbox"/> B. 5+ terms <input type="checkbox"/> C. Vectors	

3. *Decide* if the problem would be a good group practice problem (20 - 25 minutes), a good group test problem (45 - 50 minutes), or a good (easy, medium, difficult) individual test problem, depending on three factors: (a) the complexity of mathematics, (b) the timing (when problem is to be given to students), and (c) the number of difficulty characteristics of the problem:

Type of Problem	Timing	Diff. Ch.
Group Practice Problems should be shorter and mathematically easier than group test problems.	just introduced to concept(s)	2 - 3
	just finished study of concept(s)	3 - 4
Group Test Problems can be more complex mathematically.	just introduced to concept(s)	3 - 4
	just finished study of concept(s)	4 - 5
Individual Problems can be easy, medium-difficult, or difficult:		
<u>Easy</u>	just introduced to concept(s)	0 - 1
	just finished study of concept(s)	1 - 2
<u>Medium-difficult</u>	just introduced to concept(s)	1 - 2
	just finished study of concept(s)	2 - 3
<u>Difficult</u>	just introduced to concept(s)	2 - 3
	just finished study of concept(s)	3 - 4

There is considerable overlap in the criteria, so most problems can be judged to be **both** a good group practice or test problem *and* a good easy, medium-difficult, or difficult individual problem.

TASK:

Check the items in the right column that apply to each context-rich problem you solved in Homework #4. Then use the decision strategy to decide whether you think each problem is a good individual test problem, group practice problem, or group test problem [check your decision(s) in the left column]. Finally, explain your reasoning for each decision.

1. **Oil Tanker Problem:** Assume students have *just started* their study of linear kinematics (i.e., they only have the definition of average velocity and average acceleration).

Reject if:

- one-step problem
- tedious math, little physics
- problem needs "trick"

Reasons:

Decision:

- group practice problem (20 - 25 minutes);
- group test problem (45 - 50 minutes); and/or
- easy medium difficult individual problem (circle one)

Approach	Analysis	Mathematical Solution
1. Cues Lacking <input type="checkbox"/> A. No target variable <input type="checkbox"/> B. Unfamiliar context 2. Agility with Principles <input type="checkbox"/> A. Choice of principle <input type="checkbox"/> B. Two principles <input type="checkbox"/> C. Abstract principle 3. Non-Standard Application <input type="checkbox"/> A. Atypical situation <input type="checkbox"/> B. Unusual target	4. Excess or Missing Info. <input type="checkbox"/> A. Excess data <input type="checkbox"/> B. Numbers required <input type="checkbox"/> C. Assumptions 5. Seemingly Missing Info. <input type="checkbox"/> A. Vague statement <input type="checkbox"/> B. Special constraints <input type="checkbox"/> C. Diagrams 6. Additional Complexity <input type="checkbox"/> A. >2 subparts <input type="checkbox"/> B. 5+ terms <input type="checkbox"/> C. Vectors	7. Algebra required <input type="checkbox"/> A. No numbers <input type="checkbox"/> B. Unknown(s) cancel <input type="checkbox"/> C. Simultaneous eqns. 8. Targets Math Difficulty <input type="checkbox"/> A. Calc/vector algebra <input type="checkbox"/> B. Lengthy algebra

2. **Ice Skating Problem:** Assume students have *just finished* their study of the application of Newton's Laws of Motion.

Reject if:

- one-step problem
- tedious math, little physics
- problem needs "trick"

Reasons:

Decision:

- group practice problem (20 - 25 minutes);
- group test problem (45 - 50 minutes); and/or
- easy medium difficult individual problem (circle one)

Approach	Analysis	Mathematical Solution
<p>1. Cues Lacking</p> <ul style="list-style-type: none"> <input type="checkbox"/> A. No target variable <input type="checkbox"/> B. Unfamiliar context <p>2. Agility with Principles</p> <ul style="list-style-type: none"> <input type="checkbox"/> A. Choice of principle <input type="checkbox"/> B. Two principles <input type="checkbox"/> C. Abstract principle <p>3. Non-Standard Application</p> <ul style="list-style-type: none"> <input type="checkbox"/> A. Atypical situation <input type="checkbox"/> B. Unusual target 	<p>4. Excess or Missing Info.</p> <ul style="list-style-type: none"> <input type="checkbox"/> A. Excess data <input type="checkbox"/> B. Numbers required <input type="checkbox"/> C. Assumptions <p>5. Seemingly Missing Info.</p> <ul style="list-style-type: none"> <input type="checkbox"/> A. Vague statement <input type="checkbox"/> B. Special constraints <input type="checkbox"/> C. Diagrams <p>6. Additional Complexity</p> <ul style="list-style-type: none"> <input type="checkbox"/> A. >2 subparts <input type="checkbox"/> B. 5+ terms <input type="checkbox"/> C. Vectors 	<p>7. Algebra required</p> <ul style="list-style-type: none"> <input type="checkbox"/> A. No numbers <input type="checkbox"/> B. Unknown(s) cancel <input type="checkbox"/> C. Simultaneous eqns. <p>8. Targets Math Difficulty</p> <ul style="list-style-type: none"> <input type="checkbox"/> A. Calc/vector algebra <input type="checkbox"/> B. Lengthy algebra

3. Safe Ride Problem: Assume that students have *just finished* their study of forces and uniform circular motion.

Reject if:

- one-step problem
- tedious math, little physics
- problem needs "trick"

Reasons:

Decision:

- group practice problem (20 - 25 minutes);
- group test problem (45 - 50 minutes); and/or
- easy medium difficult individual problem (circle one)

Approach	Analysis	Mathematical Solution
<p>1. Cues Lacking</p> <ul style="list-style-type: none"> <input type="checkbox"/> A. No target variable <input type="checkbox"/> B. Unfamiliar context <p>2. Agility with Principles</p> <ul style="list-style-type: none"> <input type="checkbox"/> A. Choice of principle <input type="checkbox"/> B. Two principles <input type="checkbox"/> C. Abstract principle <p>3. Non-Standard Application</p> <ul style="list-style-type: none"> <input type="checkbox"/> A. Atypical situation <input type="checkbox"/> B. Unusual target 	<p>4. Excess or Missing Info.</p> <ul style="list-style-type: none"> <input type="checkbox"/> A. Excess data <input type="checkbox"/> B. Numbers required <input type="checkbox"/> C. Assumptions <p>5. Seemingly Missing Info.</p> <ul style="list-style-type: none"> <input type="checkbox"/> A. Vague statement <input type="checkbox"/> B. Special constraints <input type="checkbox"/> C. Diagrams <p>6. Additional Complexity</p> <ul style="list-style-type: none"> <input type="checkbox"/> A. >2 subparts <input type="checkbox"/> B. 5+ terms <input type="checkbox"/> C. Vectors 	<p>7. Algebra required</p> <ul style="list-style-type: none"> <input type="checkbox"/> A. No numbers <input type="checkbox"/> B. Unknown(s) cancel <input type="checkbox"/> C. Simultaneous eqns. <p>8. Targets Math Difficulty</p> <ul style="list-style-type: none"> <input type="checkbox"/> A. Calc/vector algebra <input type="checkbox"/> B. Lengthy algebra

4. **Cancer Therapy Problem:** Assume students have *just finished* their study of the conservation of energy and momentum.

Reject if:

- one-step problem
- tedious math, little physics
- problem needs "trick"

Reasons:

Decision:

- group practice problem (20 - 25 minutes);
- group test problem (45 - 50 minutes); and/or
- easy medium difficult individual problem (circle one)

Approach	Analysis	Mathematical Solution
<p>D. Cues Lacking</p> <ul style="list-style-type: none"> <input type="checkbox"/> A. No target variable <input type="checkbox"/> B. Unfamiliar context <p>E. Agility with Principles</p> <ul style="list-style-type: none"> <input type="checkbox"/> A. Choice of principle <input type="checkbox"/> B. Two principles <input type="checkbox"/> C. Abstract principle <p>F. Non-Standard Application</p> <ul style="list-style-type: none"> <input type="checkbox"/> A. Atypical situation <input type="checkbox"/> B. Unusual target 	<p>G. Excess or Missing Info.</p> <ul style="list-style-type: none"> <input type="checkbox"/> A. Excess data <input type="checkbox"/> B. Numbers required <input type="checkbox"/> C. Assumptions <p>H. Seemingly Missing Info.</p> <ul style="list-style-type: none"> <input type="checkbox"/> A. Vague statement <input type="checkbox"/> B. Special constraints <input type="checkbox"/> C. Diagrams <p>I. Additional Complexity</p> <ul style="list-style-type: none"> <input type="checkbox"/> A. >2 subparts <input type="checkbox"/> B. 5+ terms <input type="checkbox"/> C. Vectors 	<p>J. Algebra required</p> <ul style="list-style-type: none"> <input type="checkbox"/> A. No numbers <input type="checkbox"/> B. Unknown(s) cancel <input type="checkbox"/> C. Simultaneous eqns. <p>K. Targets Math Difficulty</p> <ul style="list-style-type: none"> <input type="checkbox"/> A. Calc/vector algebra <input type="checkbox"/> B. Lengthy algebra

5. **Kool Aid Problem:** Assume that students have *just finished* their study of calorimetry.

Reject if:

- one-step problem
- tedious math, little physics
- problem needs "trick"

Reasons:

Decision:

- group practice problem (20 - 25 minutes);
- group test problem (45 - 50 minutes); and/or
- easy medium difficult individual problem (circle one)

Approach	Analysis	Mathematical Solution
1. Cues Lacking <input type="checkbox"/> A. No target variable <input type="checkbox"/> B. Unfamiliar context 2. Agility with Principles <input type="checkbox"/> A. Choice of principle <input type="checkbox"/> B. Two principles <input type="checkbox"/> C. Abstract principle 3. Non-Standard Application <input type="checkbox"/> A. Atypical situation <input type="checkbox"/> B. Unusual target	4. Excess or Missing Info. <input type="checkbox"/> A. Excess data <input type="checkbox"/> B. Numbers required <input type="checkbox"/> C. Assumptions 5. Seemingly Missing Info. <input type="checkbox"/> A. Vague statement <input type="checkbox"/> B. Special constraints <input type="checkbox"/> C. Diagrams 6. Additional Complexity <input type="checkbox"/> A. >2 subparts <input type="checkbox"/> B. 5+ terms <input type="checkbox"/> C. Vectors	7. Algebra required <input type="checkbox"/> A. No numbers <input type="checkbox"/> B. Unknown(s) cancel <input type="checkbox"/> C. Simultaneous eqns. 8. Targets Math Difficulty <input type="checkbox"/> A. Calc/vector algebra <input type="checkbox"/> B. Lengthy algebra